



*moving forward in every field*

IDIOMA • ES/EN

# ACCESORIOS DE CABINA

## ▶▶ ACCESORIOS

Catálogo - Primera edición: 1995

[www.bepcoparts.com](http://www.bepcoparts.com)

Member of **TVH** 

# PRESENTACIÓN DE BEPCO

El Grupo BEPCO es líder mundial en el suministro de recambios y accesorios para tractores y máquinas agrícolas.

Con más de 360 empleados, el Grupo BEPCO tiene delegaciones en Bélgica, Holanda, Francia, Alemania, España y el Reino Unido. También está presente en Australia, Nueva Zelanda, Sudáfrica y Brasil.





El Grupo BEPCO es una compañía global con clientes en más de 100 países y con ventas fuera de Europa que contribuyen a más de una tercera parte de su facturación.

Ofrecemos a nuestra red de distribuidores y concesionarios :

- ▶▶ Marcas de proveedores de piezas originales y otras marcas líderes
- ▶▶ Más de 20.000 m<sup>2</sup> de almacenes
- ▶▶ Más de 80.000 artículos disponibles
- ▶▶ Personal experto en conocimientos técnicos
- ▶▶ Envíos el mismo día del pedido, con entregas al día siguiente en muchos mercados

El Grupo BEPCO es miembro de TVH, el mayor suministrador de piezas y accesorios de alta calidad para máquinas de manipulación, vehículos industriales y otros equipos agrícolas.

**GAZ STRUTS**  
**AMORTIGUADORES**
**CASE-IH**  
**DAVID BROWN**
**CASE-IH**  
**EUROPE**





	Windscreen <i>Parabrisas</i>	Door <i>Puerta</i>	Roof <i>Techo</i>	Rear window <i>Ventana trasera</i>
<b>CASE IH (David-Brown)</b>				
1190, 1290, 1390, 1490, 1690 (Old models / Modelos antiguos)		<b>20/872-8</b> (395mm) (K302896)	<b>20/871-7</b> (255mm) (K303741)	<b>20/870-8</b> (502mm) (K303743)
1290, 1390, 1490, 1690, 1690T, 1194, 1294, 1394, 1494, 1594, 1694		<b>20/872-9</b> (245mm) (K303870)		
<b>CASE IH (Europe)</b>				
433, 533, 633, 733, 833 (  C82 "STD", "S3" & "Luxe")	<b>25/872-11</b> (239mm) (1284622C2)	<b>25/872-11</b> (239mm) (1284622C2)		<b>25/870-9</b> (240mm) (1284636C2)
533, 633, 733, 833		<b>25/872-22</b> (500mm) (1332420C1)		
644, 744, 844, 946, 955, 1046, 1055, 1246 (  "Comfort 2000")	<b>25/872-12</b> (402mm) (3232760R2)		<b>25/871-8</b> (250mm) (3221572R1)	<b>25/870-10</b> (500mm) (3221531R1)
743, 745, 844S, 845, 955, 1055			<b>25/871-9</b> (240mm) (3399042R1)	<b>25/870-11</b> (500mm) (3225465R2)
743, 745, 844, 845, 856, 955, 956, 1055, 1056, 1255, 1455, 3210, 3220, 3230, 4210, 4220, 4230, 4240 (  XL)		<b>25/872-14</b> (278mm) (3232937R1)	<b>25/871-11</b> (224mm) (3399422R3)	<b>25/870-15</b> (550mm) (3234163R1)
856, 956, 1056, 1255, 1455			<b>25/871-9</b> (240mm) (3399042R1)	
"XL"				<b>25/870-36</b> (500mm) (3148826R2)
5120, 5130, 5140, 5150		<b>25/872-44</b> (250mm) (1977416C1)	<b>25/871-11</b> (224mm) (3399422R3)	<b>25/870-31</b> (478mm) (1971235C2)
7110E, 7120E, 7130, 7140, 7210, 7220, 7230, 7240, 7250		<b>25/872-21</b> (330mm) (1280263C1)		<b>25/870-32</b> (305mm) (1343825C1)
9270, 9280, 9310, 9330, 9350, 9370, 9380, 9390, MX180, MX200, MX220, MX240, MX270				
CS48, CS58, CS68, CS75	<b>25/870-34</b> (485mm) (1-99-976-066)	<b>25/872-64</b> (501mm) (1-34-701-577)		
CS78, CS86, CS94, CS110, CS120, CS130, CS150, CVX120, CVX130, CVX150, CVX170		<b>25/870-60</b> (205mm) (1-99-976-061)	<b>25/871-43</b> (276mm) (1-99-976-036)	<b>25/870-34</b> (485mm) (1-99-976-066)
CX50, CX60, CX70, CX80, CX90, CX100, MX80C, MX90C, MX100C, MX100, MX110, MX120, MX135, MX150, MX170	<b>25/870-33</b> (487mm) (189447A2)	<b>25/872-44</b> (250mm) (1977416C1)		<b>25/870-33</b> (487mm) (189447A2)
<b>Bonnet / Capó</b>				
Maxxum 5120	<b>25/876-1</b> (402mm) (1531489C1)			
Maxxum 5130, 5140, 5150	<b>25/876-2</b> (400mm) (1531490C1)			
Maxxum 5120, 5130, 5140, 5150	<b>25/876-3</b> (227mm) (108157A1)			

 Part numbers are quoted for reference purposes only.  
 Our parts and accessories are not original.

 Las referencias originales tienen un propósito identificativo.  
 Nuestras piezas no son originales.

**"THE RELIABLE SERVICE"**

	<b>CASE-IH</b> ENGLAND	<b>KHD-DEUTZ</b>	<b>GAZ STRUTS</b> <b>AMORTIGUADORES</b>	
---	---------------------------	------------------	--	--

	Windscreen <i>Parabrisas</i>	Door <i>Puerta</i>	Roof <i>Techo</i>	Rear window <i>Ventana trasera</i>
<b>CASE IH (England)</b>				
485, 585, 685, 695, 785, 795, 885, 895, 995 (  "XL")		<b>25/872-14</b> (278mm) (3232937R1)	<b>25/871-11</b> (224mm) (3399422R3)	<b>25/870-15</b> (550mm) (3234163R1)
384, 484, 584, 684, 784, 884, 385, 485, 585, 685, 785, 885 (  "L")		<b>25/870-13</b> (285mm) (3123040R1)	<b>25/871-10</b> (255mm) (3123835R1)	<b>25/870-12</b> (285mm) (3118430R1)
484, 584, 684, 784, 884, 485, 585, 685, 785, 885 (  "Super De Luxe")				<b>25/870-14</b> (422mm) (3125425R1)
3210, 3220, 3230, 4210, 4220, 4230, 4240 (  "LP")		<b>25/872-22</b> (500mm) (1332420C1)		<b>25/870-35</b> (450mm) (144947A2)
<b>KHD-DEUTZ</b>				
D45 07C, D48 07C, D52 07C, D60 07C, D62 07C, D65 07C, D68 07C, D69 07C, D70 07C, D72 07C, D78 07C	<b>21/870-45</b> (505mm) (04357777)	<b>21/870-45</b> (505mm) (04357777)	<b>21/871-25</b> (253mm) (04316669)	<b>21/870-45</b> (505mm) (04357777)
D68 07, D72 07, D78 07				<b>21/871-25</b> (253mm) (04316669)
DX80, 85, 86, 90, 92, 110, 120, 145	<b>21/870-46</b> (505mm) (04344257)	<b>21/872-35</b> (611mm) (04356301)		
DX4.10, 4.30, 4.50, 4.70, 6.05, 6.10, 6.30, 6.50, 7.10	<b>21/870-47</b> (505mm) (04357776)	<b>21/872-36</b> (611mm) (04373763)		<b>21/870-47</b> (505mm) (04357776)
	<b>21/870-45</b> (505mm) (04357777)		<b>21/870-45</b> (505mm) (04357777)	
DX85, 90, 110, 120, 140, 145, 160, 230, 250	<b>21/870-48</b> (505mm) (04336970)			<b>21/870-48</b> (505mm) (04336970)
DX3.10VC, 3.30VC, 3.50VC, 3.60VC, 3.65VC, 3.70VC, 3.90VC				<b>21/870-66</b> (500mm) (04335085)
DX3.10V, 3.30V/F, 3.50V/F/S, 3.70V/F, 3.90F/S	<b>21/874-21</b> (500mm) (04366129)	<b>21/870-94</b> (278mm) (04366164)	<b>21/870-94</b> (278mm) (04366164)	<b>21/870-94</b> (278mm) (04366164)
DX3.10SC, 3.30SC, 3.50SC, 3.60SC, 3.65SC, 3.70SC, 3.80SC, 3.90SC, AgroPrima 4.31, 4.51, 4.56, 6.06, 6.16, AgroXtra 3.57, 4.07, 4.17, 4.47, 4.57, 6.07, 6.17	<b>21/870-49</b> (505mm) (04388075)	<b>21/872-34</b> (505mm) (04373761)	<b>21/871-25</b> (253mm) (04316669)	<b>21/870-49</b> (505mm) (04388075)
	<b>21/870-50</b> (505mm) (04399081)	<b>21/872-40</b> (500mm) (04402639)		<b>21/870-50</b> (505mm) (04399081)
AgroStar 4.61, 4.68, 4.71, 4.78, 6.08, 6.11, 6.21, 6.28, 6.31, 6.38, 6.61, 6.71, 6.81		<b>21/872-38</b> (500mm) (04403124)		
	<b>21/870-45</b> (505mm) (04357779)			<b>21/870-45</b> (505mm) (04357779)
Agrotron 4.70, 4.80, 4.85, 4.90, 4.95, 6.00, 6.01, 6.05, 6.15, 6.20, 6.30, 6.45, 160, 175, 200	<b>21/870-52</b> (535mm) (04415239)	<b>21/872-39</b> (235mm) (04428681)		<b>21/870-52</b> (535mm) (04415239)
Agro Compact 3.30V/F, 3.50V/F/S, 3.70V/F, 3.90F/S	<b>21/874-21</b> (500mm) (04366129)	<b>21/870-94</b> (278mm) (04366164)	<b>21/870-94</b> (278mm) (04366164)	<b>21/874-21</b> (500mm) (04366129)

Part numbers are quoted for reference purposes only.  
Our parts and accessories are not original.

Las referencias originales tienen un propósito identificativo.  
Nuestras piezas no son originales.











**"THE RELIABLE SERVICE"**



VER-2

Ed. 1 (01/03)

**GAZ STRUTS  
 AMORTIGUADORES**
**DIETEG**
**FENDT**











	Windscreen <i>Parabrisas</i>	Door <i>Puerta</i>	Roof <i>Techo</i>	Rear window <i>Ventana trasera</i>
<b>DIETEG</b>				
 F8000, FP8000, FPK8000	<b>40/874-10</b> (215mm) (32147)			
 Compact 80 Deutz	<b>40/870-79</b> (595mm) (010008100)	<b>40/870-79</b> (595mm) (010008100)		<b>40/870-67</b> (605mm)
 Compact 80 Case IH	<b>40/874-13</b> (485mm) (01008088)			
 Compact 50 Deutz, Case IH, John Deere	<b>40/874-12</b> (340mm) (010008062)	<b>40/872-47</b> (340mm)		
 Compact 90 Deutz				
 Compact 10 Deutz DX smalspoor	<b>40/870-79</b> (595mm) (010008100)			
	<i>Side window Ventana lateral</i>			
 Compact 80 Deutz, Case IH Compact 90 Deutz	<b>40/873-3</b> (183mm) (010008010)			
<b>FENDT</b>				
Farmer Serie 100 LS <i>Serie</i>	<b>22/874-18</b> (500mm) (A) (F182800202060)	<b>22/872-55</b> (278mm) (F258514210020)	<b>22/871-33</b> (222mm) (X800420446000)	
	<b>22/874-19</b> (430mm) (B) (F182800200210)			
Farmer 200V, 203P, 204P, 204V				<b>22/870-70</b> (500mm) (F166810040010)
Farmer 240, 250, 260, 270, 275, 280 S, P, V	<b>22/870-68</b> (500mm) (H205810040030)	<b>22/872-55</b> (278mm) (F258514210020)	<b>22/871-33</b> (222mm) (X800420446000)	<b>22/870-71</b> (405mm) (H205810050100)
	<b>22/872-55</b> (278mm) (C) (F258514210020)			
Farmer Serie 300 LS, LSA <i>Serie</i> Favorit Serie 600 LS, LSA <i>Serie</i>	<b>22/870-21</b> (592mm) (X800420490000)	<b>22/872-16</b> (501mm) (X800420414000)		
		<b>22/872-57</b> (490mm) (X800420491000)		
Favorit Series 500, 700, 800, 900 <i>Series</i>	<b>22/870-69</b> (603mm) (X800420489000)	<b>22/872-49</b> (325mm) (H816810030500)	<b>22/871-30</b> (215mm) (H816810020100)	<b>22/870-68</b> (500mm) (H205810040030)
F 255 GT, F 275 GT	<b>22/874-15</b> (305mm) (X800420422000)			
F 345 GT, F 350 GT, F 360 GT, F 365 GT, F 370 GT, F 380 GT, F 390 GT, F 395 GT	<b>22/870-21</b> (592mm) (X800420490000)	<b>22/872-57</b> (490mm) (X800420491000)	<b>22/871-33</b> (222mm) (X800420446000)	<b>22/870-21</b> (592mm) (X800420490000)
Xylon 520, 522, 524			<b>22/871-30</b> (215mm) (H816810020100)	<b>22/870-68</b> (500mm) (H205810040030)
	<b>Bonnet / Capó</b>			
Series 700, 900 <i>Series</i> <i>New generation</i> <i>Nueva generación</i>	<b>22/876-4</b> (590mm) (H716501021200)			

(A) Squared windscreen / *Parabrisas puntas cuadradas*  
 (B) Round windscreen / *Parabrisas puntas redondas*  
 (C) With front loader / *Con pala cargadora*

Part numbers are quoted for reference purposes only.  
 Our parts and accessories are not original.

Las referencias originales tienen un propósito identificativo.  
 Nuestras piezas no son originales.











 <b>FIATAGRI</b> NEW HOLLAND		<b>FORD</b> NEW HOLLAND		<b>GAZ STRUTS</b> <b>AMORTIGUADORES</b>	
		<b>Windscreen</b> <i>Parabrisas</i>	<b>Door</b> <i>Puerta</i>	<b>Roof</b> <i>Techo</i>	<b>Rear window</b> <i>Ventana trasera</i>
<b>FIATAGRI NEW HOLLAND</b>					
Serie "80" Serie	<b>23/870-1</b> (495mm) (9933355, 62750096)	<b>23/870-1</b> (495mm) (9933355, 62750096)			
Series / Series 46, 56, 66, 66S, 76, 80, 86, 90, 94			<b>23/871-16</b> (260mm) (5125289, 5116437, 5108535)		<b>23/870-23</b> (500mm) (5113767)
 Comfort, Super Comfort					
 Geotech 83 Serie "90" Serie					<b>23/870-22</b> (498mm) (5129427)
Serie "Winner" Serie	<b>23/870-58</b> (637mm) (5155032)	<b>23/870-55</b> (540mm) (5147419)	<b>23/871-11</b> (224mm) (5153206)		<b>23/870-56</b> (640mm) (5153193)
L60, L65, L75, L85, L95		<b>23/872-69</b> (215mm) (5183854)			
M100, M115, M135, M160, TM115, TM125, TM135, TM150, TM165, TS90, TS100, TS110, TS115		<b>23/872-42</b> (215mm) (81867743, 83994021)	<b>23/871-42</b> (215mm) (83949895)		<b>23/870-57</b> (585mm) (82019393, 83995329)
<b>FORD NEW HOLLAND</b>					
2310, 2610, 2810, 2910, 3610, 3910, 4110, 4610, 5110, 5610, 6410, 6610, 6710, 6810, 7410, 7610	<b>24/874-1</b> (255mm) (E3NN94032N09AA11M, 83944280)	<b>24/872-6</b> (500mm) (E3NN94201N18AA, 83944272)		<b>24/871-5</b> (255mm) (E2NN94502R28AA, 83932028)	<b>24/870-7</b> (500mm) (E2NN9444000AA, 83932024)
 LP (1/82 ⇒ 1/84) AP (2/84 ⇒)					
3430, 3930, 4130, 4630, 4830, 5030		<b>24/872-7</b> (200mm) (E9NN9423552AB, 81878231)			
5110, 5610, 5900, 6610, 6710, 7610, 7710, 7910, 8210, TW5, TW15, TW25, TW35 (10/85 ⇒) 6410, 6810, 7410, 7810, 8530, 8630, 8730, 8830 Gen. I		<b>24/872-5</b> (200mm) (E4NN94201N18AA, 83952266)	<b>24/871-4</b> (215mm) (E4NN94502R28AA, 83949895)		<b>24/870-6</b> (375mm) (E4NN9444000AA, 83952213)
 Super Q					
Serie 10 serie Gen. II		<b>24/872-68</b> (215mm)			
4635, 4835, 5635, 6635, 7635, TL70, TL80, TL90, TL100					
5640, 6640, 7740, 7840, 8160, 8240, 8260, 8340, 8360, 8560, TM115, TM125, TM135, TM150, TM165, TS90, TS100, TS110, TS115		<b>24/872-42</b> (215mm) (E9NN94201N18AB, 81867743)	<b>24/871-4</b> (215mm) (E4NN94502R28AA, 83949895)		<b>24/870-57</b> (585mm) (F0NN9444000BA, 81865239, 82019393)
	<b>Side window</b> <i>Ventana lateral</i>				<b>Rear window</b> <i>Ventana trasera</i>
2600, 3600, 4100, 4600, 5600, 5700, 6600, 6700, 7600, 7700, 8700, 9700, TW10, TW20, TW30	<b>24/873-1</b> (370mm) (B) (D7NN94303N04D, 83917053)	(A) With support / <i>Con soportes</i> (B) Spring struts fits left-hand front and right-hand rear, side windows <i>Amortiguador montado sobre ventanas laterales frontal izda. y trasera drcha.</i> (C) Spring struts fits right-hand front and left-hand rear, side windows <i>Amortiguador montado sobre ventanas laterales frontal drcha. y trasera izda.</i>			<b>24/870-5</b> (370mm) (A) (D7NN94303N04A, 83917049)
2610, 3610, 3910, 4110, 4610 (⇒ 12/85)					
5110, 5610, 5900, 6610, 6710, 7610, 7710, 7910, 8210, TW5, TW15, TW25, TW35 (⇒ 9/85)	<b>24/873-2</b> (370mm) (C) (D7NN94303N05C, 83917055)				
 Q					
Part numbers are quoted for reference purposes only. Our parts and accessories are not original.		 <b>"THE RELIABLE SERVICE"</b> 		Las referencias originales tienen un propósito identificativo. Nuestras piezas no son originales.	

VER-4

Ed. 1 (01/03)



<b>GAZ STRUTS</b> <b>AMORTIGUADORES</b>	<b>HILL BRANT</b>	<b>HÜRLIMANN</b>	<b>JOHN DEERE</b>	
--	-------------------	------------------	-------------------	---



	Windscreen <i>Parabrisas</i>	Door <i>Puerta</i>	Roof <i>Techo</i>	Rear window <i>Ventana trasera</i>
<b>HILL BRANT</b>				
 Hill Brant		<b>40/870-95</b> (400mm)		<b>40/870-95</b> (400mm)
<b>HÜRLIMANN</b>				
H356, H358, H466, H476, H468, H478, H488		<b>33/872-59</b> (500mm) (9241.140.4)	<b>33/871-35</b> (318mm) (9234.373.4)	<b>33/870-84</b> (520mm) (9206.198.4/10)
480, 490, 5110				
XT				<b>33/870-85</b> (700mm) (007.5407.0)
6115, 6135		<b>33/872-60</b> (390mm) (008.2089.4/20)		
<b>JOHN DEERE</b>				
1030, 1130, 1630 (  "SEKURA", "SEK 442", "OPU")			<b>26/870-17</b> (255mm) (AL28599)	<b>26/870-17</b> (255mm) (AL28599)
1830, 2030, 2130 (  "SEKURA", "SEK 293", "SEK927")			<b>26/871-13</b> (255mm) (AL28649, AL25968)	
2030, 2130, 3030, 3130 (  "SEKURA", "SEK 294", "SEK 443")			<b>26/870-17</b> (255mm) (AL28599)	<b>26/870-19</b> (500mm) (AL58521, AL60324, AL63124)
940, 1040, 1140, 1550, 1640, 1750, 1850, 1950, 2040, 2040S, 2250, 2450, 2650, 2850 (  "MC1")	<b>26/874-4</b> (323mm) (AL61021)	<b>26/870-19</b> (500mm) (AL58521, AL60324, AL63124)	<b>26/871-14</b> (224mm) (L57248)	<b>26/870-18</b> (500mm) (AL33170)
940, 1040, 1140, 1640, 2040, 2040S, 2140, 3040, 3140 (  "OPU")	<b>26/870-19</b> (500mm) (AL58521, AL60324, AL63124)		<b>26/870-17</b> (255mm) (AL28599)	
1640, 2040, 2040S, 2140, 2250, 2450, 2650, 2850, 3040, 3050, 3140, 3350, 3640, 3650 (  "SG2")				
4040S, 4055, 4240, 4240S, 4250, 4255, 4440, 4450, 4455, 4640, 4650, 4680, 4755, 4850, 4955				
6100(SE), 6200(SE), 6300(SE), 6400(SE), 6506, 6600, 6800, 6900		<b>26/872-50</b> (260mm) (AL110629, AL78435)		<b>26/870-72</b> (500mm) (AL77303, AL81578)
6101SE, 6110(SE), 6210(SE), 6310(SE), 6410(SE), 6510(SE), 6610(SE), 6810, 6910				<b>26/870-73</b> (500mm) (AL114803)
7600, 7610, 7700, 7710, 7800, 7810				<b>26/870-72</b> (500mm) (AL77303, AL81578)
<b>Bonnet / Capó</b>				
6100, 6200, 6300, 6400, 6505, 6506, 6510(SE), 6600, 6610(SE), 6800, 6810, 6900, 6910(S)	<b>26/876-5</b> (354mm) (AL77767)			

Part numbers are quoted for reference purposes only.  
 Our parts and accessories are not original.

Las referencias originales tienen un propósito identificativo.  
 Nuestras piezas no son originales.



	<b>LAMBORGHINI</b>	<b>LANDINI</b>	<b>MANITOU</b>	<b>GAZ STRUTS AMORTIGUADORES</b>
---	--------------------	----------------	----------------	--------------------------------------

	Windscreen <i>Parabrisas</i>	Door <i>Puerta</i>	Roof <i>Techo</i>	Rear window <i>Ventana trasera</i>
<b>LAMBORGHINI</b>				
R.674, R.874	<b>32/872-61</b> (500mm) (9233.166.4)	<b>32/872-61</b> (500mm) (9233.166.4)	<b>32/871-36</b> (318mm) (9234.373.4)	<b>32/872-61</b> (500mm) (9233.166.4)
R.956, R.1106, R.1306, R.1506				
R.774				
R.774-80, R.874T				<b>32/870-86</b> (500mm) (9233.167.0)
R.874-90T, R.974-90T Grand Prix, 105 Formula		<b>32/872-61</b> (500mm) (9233.166.4)		
Premium 850, 950, 1050, 1060		<b>32/872-62</b> (390mm) (008.2089.4/20)		<b>32/870-87</b> (700mm) (007.5407.0)
Racing 150, 165, 190				
<b>LANDINI</b>				
5500			<b>31/871-26</b> (255mm) (1427157M91)	
Large 12500, 14500				<b>31/870-88</b> (550mm) (1427130M92)
6550, 8550, 6880, 7880, 8880, 9080, 9880, Large 10000, 13000			<b>31/871-38</b> (215mm) (3303021M91)	<b>31/870-89</b> (525mm) (3301920M92)
Legend 105, 115, 130, 145, 165				
<b>MANITOU</b>				
	Bonnet <i>Capó</i>	Tank bonnet <i>Deposito en capó</i>	Rear window <i>Ventana trasera</i>	
MC40, MC50 (Powershift) (1 & 2 Serie) MC60, MC70 (Turbo Powershift) (1 & 2 Serie)	<b>44/876-6</b> (585mm) (214241)			
M26-2, M26-4, M30-2, M40-2, M40-4 (1 & 2 Serie), MC30	<b>44/876-7</b> (585mm) (213461)			
MT930	<b>44/876-8</b> (380mm) (404719)			
M30-4, MC40, MC50, MC60, MC70 (⇒ S170800), MT732, MT835, MT932, MT1332H, MT1337, MT1637, MLT629, MLT633, MLT730, MLT735H, MLT740H, MLT740T	<b>44/876-9</b> (525mm) (226681,240923)			
165ATJ, 165ATJS (2 Serie)	<b>44/876-10</b> (365mm) (498542)			
MLT523, MLT526 (1 Serie)	<b>44/876-11</b> (885mm) (232509)	<b>44/876-12</b> (585mm) (223523)		
MLA628T, MLT 523, MLT526 (1 Serie)	<b>44/876-12</b> (585mm) (223523)			
MT835, MT1337, MT1637	<b>44/876-9</b> (525mm) (226681,240923)			
MT835, MT1330, MT1337, MT1637 (1 Serie)	<b>44/876-6</b> (585mm) (214241)			
MC60, MT727, MT728, MT927, MT928, MLT628, MLT632, MLT728	<b>44/876-15</b> (885mm) (209377)			
M2 26 CP, M2 30 CP, M4 26 CP, M4 30 CP, M4 40 CP, M4 50 CP, MC 30 CP, MC 40 CP, MC 50 CP, MCE 40 CP, MLT523, MLT526 (1 Serie)	<b>44/876-16</b> (585mm) (174114)			

Part numbers are quoted for reference purposes only.  
Our parts and accessories are not original.

Las referencias originales tienen un propósito identificativo.  
Nuestras piezas no son originales.





**"THE RELIABLE SERVICE"**





**GAZ STRUTS**  
**AMORTIGUADORES**
**MANITOU**
**MASSEY  
FERGUSON**

	Bonnet <i>Capó</i>	Tank bonnet <i>Deposito en capó</i>	Rear window <i>Ventana trasera</i>	
<b>MANITOU</b>				
MT727, 927 (Serie C), MT830, MT840, MT930, MT1230, MLT626, MLT630, MLT725 (2 & 3 Series)	<b>44/876-17</b> (885mm) (78442)			
MLT626, MLT630, MLT725 (2 & 3 Series)		<b>44/876-20</b> (887mm) (189010)		
MSI20, MSI25, MSI30	<b>44/876-18</b> (500mm) (211101)			
MT830, MT840, MT930, MT1230 (1 Serie)		<b>44/876-21</b> (887mm) (184499)		
MLT626 (1 Serie)	<b>44/876-19</b> (885mm) (78857)			
MT732, MT835, MT845, MT932, MT940, MT1232, MT1240, MT1330, MT1332, MT1337, MT1637, MLT523, MLT526, MLT629, MLT633, MLT730 (A Serie)			<b>44/870-102</b> (315mm) (551569)	
	Windscreen <i>Parabrisas</i>	Door <i>Puerta</i>	Roof <i>Techo</i>	Rear window <i>Ventana trasera</i>
<b>MASSEY FERGUSON</b>				
154, 174, 184, 194		<b>30/872-51</b> (317mm) (3103957M1)		
154, 254, 274, 1114, 1134			<b>30/871-37</b> (255mm) (1427157M91)	
Serie 200 Serie Sankey LPQ			<b>30/871-3</b> (215mm) (1897726M91)	<b>30/870-3</b> (497mm) (1897990M91, 3476187M1)
342, 350, 352, 355, 360, 362, 365, 372, 375, 382, 390, 396, 398, 399		<b>30/872-2</b> (280mm) (3478319M2, 3476027M1)		
233, 253, 263, 273, 283, 293, 333, 353, 363, 373, 383, 393	<b>30/870-74</b> (361mm) (3103958M1)	<b>30/872-51</b> (317mm) (3103957M1)		<b>30/870-74</b> (361mm) (3103958M1)
354, 364, 374, 384, 394				<b>30/872-51</b> (317mm) (3103957M1)
				<b>30/870-74</b> (361mm) (3103958M1)
Serie 500 Serie Combines / Cosechadoras 530, 535, 560, 565, 660, 665, 800, 805, 810, 815, 820, 825, 830, 835, 840, 845, Ind 20E, 30D				<b>30/870-1</b> (495mm) (1873903M91)
Serie 600 Serie, 274SK, 284S, 294S, 377, 387, 397, 397T, 1004, 1004T, 1007, 1014, 1024				<b>30/870-2</b> (525mm) (3301920M92)
Series 2600, 2700 Series		<b>30/872-1</b> (505mm) (3380149M2)	<b>30/871-1</b> (215mm) (3303021M91, 3301617M91)	<b>30/870-1</b> (495mm) (3384671M1, 1873903M91)
Serie 3000 Serie	<b>30/870-74</b> (361mm) (3103958M1)	<b>30/872-3</b> (250mm) (3385316M91)		<b>30/870-74</b> (361mm) (3103958M1)
Series 3100, 3600 Series			<b>30/870-4</b> (786mm) (3389556M2) (190 N)	
Series 4200, 4300 Series	<b>30/870-53</b> (485mm) (3805354M1, 3804759M1, 3806767M1)	<b>30/870-53</b> (485mm) (3805354M1, 3804759M1)	<b>30/871-39</b> (215mm) (3901826M91)	<b>30/870-53</b> (485mm) (3805354M1, 3804759M1)
Series 6100, 6200, 8100, 8200 Series		<b>30/872-43</b> (227mm) (3902121M3)	<b>30/871-1</b> (215mm) (3303021M91)	<b>30/870-63</b> (585mm) (3902140M1)





 Part numbers are quoted for reference purposes only.  
 Our parts and accessories are not original.

 Las referencias originales tienen un propósito identificativo.  
 Nuestras piezas no son originales.

Ed. 1 (01/03)

**"THE RELIABLE SERVICE"**







VER-7

	<b>MINSK TRACTORS</b>	<b>RENAULT D.M.A.</b>	<b>SAME</b>	<b>GAZ STRUTS AMORTIGUADORES</b>	
	<b>Windscreen Parabrisas</b>	<b>Door Puerta</b>	<b>Roof Techo</b>	<b>Rear window Ventana trasera</b>	
<b>MINSK TRACTORS BELARUS</b>					
MTS 80, 82, 102, 550, 920, 952			<b>39/870-65</b> (600mm) (308250111)	<b>39/870-65</b> (600mm) (308250111)	
<b>RENAULT D.M.A.</b>					
301, 351, 361, 421, 461, 462, 466, 521, 551, 651, 652, 656, 681, 751		<b>28/872-19</b> (490mm) (7701350668)		<b>28/870-54</b> (490mm) (7701025587)	
751, 781, 851		<b>28/870-26</b> (590mm) (7700002849)			
891, 951, 981, 1151, 1181				<b>28/870-26</b> (590mm) (7700002849)	
55-12, 55-14, 70-12, 70-14				<b>28/870-61</b> (325mm) (6005014318)	
58-12, 58-14, 58-32, 58-34, 61-12, 61-14, 65-12, 65-14, 65-32, 65-34, 68-12, 68-14, 70-12, 70-14, 70-32, 70-34, 75-12, 75-14, 75-32, 75-34, 80-12, 80-14, 80-32, 80-34, 85-32, 85-34, 90-32, 90-34, 95-12, 95-14, 103-12, 103-14, 106-14, Ceres 65, 70, 75, 85, 95, 310, 320, 330, 340				<b>28/870-24</b> (375mm) (7700005276)	
75-32, 75-34, 85-32, 85-34, 90-32, 90-34, 95-12, 95-14, 103-12, 103-14, 103-52, 103-54, 106-14, 106-54, 110-14, 110-54, 113-12, 113-14, 120-14, 120-54, 133-14, 133-54, 145-14, 145-54, 155-54, 160-94, 175-74, 180-94, Temis 550, 610, 630, 650				<b>28/870-25</b> (600mm) (7700002848, 7700037427, 7700687189, 7700687409)	
Ares 540, 550, 610, 620, 630, 640	<b>28/874-7</b> (630mm) (7700047061)				
Ergos 85, 95, 105		<b>28/872-26</b> (252mm) (6005014361)		<b>28/870-61</b> (325mm) (6005014318)	
Cergos 330, 340, 350				<b>28/870-61</b> (325mm) (6005014318) <b>28/870-62</b> (365mm) (6005022224)	
<b>SAME</b>					
Antares, Titan	<b>29/874-20</b> (255mm) (9200.170.3)	<b>29/872-23</b> (390mm) (008.2089.4/20)	<b>29/871-34</b> (318mm) (9234.373.4)	<b>29/872-37</b> (700mm) (007.5407.0)	
Aster				<b>29/870-27</b> (512mm) (9208.140.3)	
Buffalo, Centauro, Centurion, Leopard, Taurus		<b>29/872-58</b> (500mm) (9241.140.4, 9233.166.4)	<b>29/871-34</b> (318mm) (9234.373.4)	<b>29/874-6</b> (500mm) (9206.194.4)	
Explorer				<b>29/870-27</b> (512mm) (9208.140.3)	
Explorer II 60, 70, 80, 90		<b>29/872-58</b> (500mm) (9241.140.4, 9233.166.4)	<b>29/871-34</b> (318mm) (9234.373.4)	<b>29/870-38</b> (520mm) (9206.198.4/10)	
Galaxy				<b>29/870-83</b> (500mm) (9233.167.4)	
Hercules		<b>29/872-58</b> (500mm) (9241.140.4, 9233.166.4)			
<p>Part numbers are quoted for reference purposes only. Our parts and accessories are not original.  <b>"THE RELIABLE SERVICE"</b> </p> <p style="text-align: right;"><i>Las referencias originales tienen un propósito identificativo. Nuestras piezas no son originales.</i></p>					

VER-8

Ed. 1 (01/03)

<b>GAZ STRUTS</b> <b>AMORTIGUADORES</b>	<b>SAME</b>	<b>STEYR</b>	<b>VALMET</b>	
--	-------------	--------------	---------------	---





	Windscreen <i>Parabrisas</i>	Door <i>Puerta</i>	Roof <i>Techo</i>	Rear window <i>Ventana trasera</i>
<b>SAME</b>				
Jaguar	<b>29/874-20</b> (255mm) (9200.170.3)	<b>29/872-58</b> (500mm) (9241.140.4, 9233.166.4)	<b>29/872-58</b> (500mm) (9241.140.4, 9233.166.4)	<b>29/870-27</b> (512mm) (9208.140.3)
Laser			<b>29/871-34</b> (318mm) (9234.373.4)	<b>29/870-83</b> (500mm) (9233.167.4)
Solar				
Tiger, Trident			<b>29/872-58</b> (500mm) (9241.140.4, 9233.166.4)	<b>29/872-58</b> (500mm) (9241.140.4, 9233.166.4)
<b>STEYR</b>				
Serie 80 Serie,  SK2		<b>27/872-53</b> (325mm) (1-99-976-060)		<b>27/870-76</b> (582mm) (1-99-976-047)
Serie 80 Serie, 8150, 8170,  FK1				<b>27/870-75</b> (571mm) (1-99-976-005)
Serie 80 Serie			<b>27/871-31</b> (276mm) (1-99-976-036)	
CVT 120, 130, 150, 170, 9105, 9115, 9125, 9145, M9078, M9083, M9086, M9094		<b>27/872-63</b> (205mm) (1-99-976-061)	<b>27/871-32</b> (205mm) (1-99-976-062)	<b>27/870-90</b> (485mm) (1-99-976-066)
Serie 900 Serie,  DUO	<b>27/870-90</b> (485mm) (1-99-976-066)	<b>27/872-54</b> (501mm) (1-34-701-577)		
M968, M975				<b>27/870-90</b> (485mm) (1-99-976-066)
8045, 8055, 8065, 8075, 8085,  RSK2		<b>27/872-52</b> (316mm) (1-34-701-485)		
8075				<b>27/870-77</b> (485mm) (1-99-976-051)
8060	<b>27/874-17</b> (483mm) (1-99-976-048)			<b>27/870-78</b> (504mm) (1-34-701-526)
8085, 8090				
<b>VALMET</b>				
205, 305, 405, 415, 504, 604				<b>41/870-99</b> (500mm) (30314200)
255, 355, 365, 455, 465, 555, 565		<b>41/872-66</b> (345mm) (31517900)		
505, 515, 605, 615, 655, 705, 715, 755, 805, 815, 855, 905, 915		<b>41/872-65</b> (600mm) (30191700)		<b>41/870-96</b> (500mm) (30077200)
600, 700, 800, 865, 900				
5180HI, 5480HI, 6000, 6100, 6250HI, 6300, 6350HI, 6400, 6550HI, 6600, 6650HI, 6800, 6850HI, 8000, 8050, 8050HI, 8100, 8150, 8200, 8350HI, 8400, 8450, 8550, 8550HI, 8750, 8950HI		<b>41/872-66</b> (345mm) (31517900)	<b>41/871-40</b> (280mm) (32241400)	<b>41/870-97</b> (520mm) (31631300)
8300, 8600, 8800		<b>41/872-67</b> (250mm) (F33853161)	<b>41/871-41</b> (215mm) (F33030211)	<b>41/870-98</b> (786mm) (F33895561)

Part numbers are quoted for reference purposes only.  
Our parts and accessories are not original.

Las referencias originales tienen un propósito identificativo.  
Nuestras piezas no son originales.



	<b>VOLVO</b>	<b>ZETOR</b>	<b>GAZ STRUTS AMORTIGUADORES</b>
---	--------------	--------------	--------------------------------------

	Windscreen <i>Parabrisas</i>	Door <i>Puerta</i>	Roof <i>Techo</i>	Rear window <i>Ventana trasera</i>
<b>VOLVO</b>				
				<b>36/870-42</b> (237mm) (BM782481)
<b>ZETOR</b>				
3320, 3340, 4320, 4340, 5320, 5340(H), 6320, 6340 (  "BK6011")		<b>37/870-91</b> (420mm) (60117921)	<b>37/870-93</b> (313mm) (62117932)	<b>37/870-91</b> (420mm) (60117921)
3320, 3340, 4320, 4340, 5320, 5340(H), 6320, 6340 (  "BK7011M")		<b>37/870-93</b> (313mm) (62117932)		<b>37/870-93</b> (313mm) (62117932)
4321, 4341, 5321, 5341, 6321, 6341, 7321, 7341		<b>37/872-71</b> (410mm) (53369903)		
5211, 5245, 6211, 6245, 7211, 7245(H), 7711, 7745 (  "BK6011")		<b>37/870-91</b> (420mm) (60117921)	<b>37/870-93</b> (313mm) (62117932)	<b>37/870-91</b> (420mm) (60117921)
7520 ⇒ 9450, 10520, 10540 Old models / <i>Modelos antiguos</i>				<b>37/870-101</b> (505mm) (10368911)
7520 ⇒ 9450, 10520, 10540 New models / <i>Modelos nuevos</i>		<b>37/872-70</b> (277mm) (10368919)	<b>37/871-44</b> (274mm) (10368916)	<b>37/870-100</b> (508mm) (10368917)
8111, 8145, 9111, 9145, 10111, 10145, 12111, 12145, 14145, 16145		<b>37/870-92</b> (400mm) (12190101, LP.3482)		<b>37/870-92</b> (400mm) (12190101, LP.3482)
8211, 8245, 9211, 9245, 10211, 10245, 11211, 11245, 12211, 12245, 14245, 16245				

Part numbers are quoted for reference purposes only.  
Our parts and accessories are not original.

*Las referencias originales tienen un propósito identificativo.  
Nuestras piezas no son originales.*



**"THE RELIABLE SERVICE"**



GAZ STRUTS  
AMORTIGUADORES

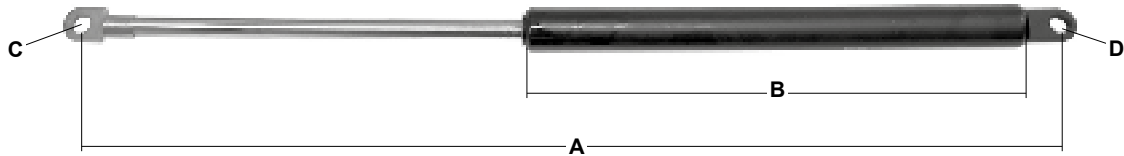

Ref. Ref.	A (mm)	B (mm)	C (mm)	D (mm)	Newtons	Ref. Ref.	A (mm)	B (mm)	C (mm)	D (mm)	Newtons
70/870-500	222	120	8	6	120	70/870-510	402	205	8	8	250
70/870-501	224	105	6	6	160	70/870-511	485	250	8	8	150
70/870-502	227	117	6	6	75	70/870-626	498	245	8	8	150
70/870-503	250	122	6	6	150	70/870-512	500	245	8	8	130
70/870-504	255	125	8	8	275	70/870-513	550	270	8	8	275
70/870-505	255	132	8	8	180	70/870-627	585	288	8	8	400
70/870-506	305	165	6	6	250	70/870-628	585	288	8	8	700
70/870-507	315	160	8	8	100	70/870-514	597	298	8	8	150
70/870-508	361	175	8	8	250	70/870-629	600	305	8	8	200
70/870-625	365	182	6	6	350	70/870-630	885	447	8	8	800
70/870-509	400	205	8	8	330	70/870-631	885	447	8	8	1000

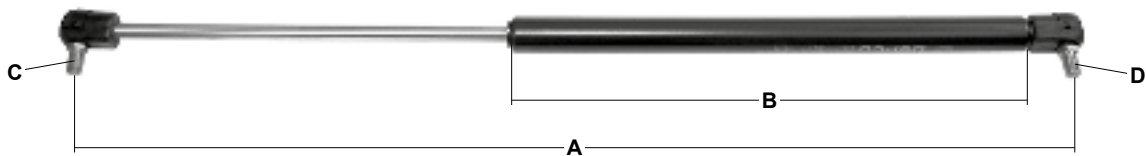

Ref. Ref.	A (mm)	B (mm)	C (mm)	D (mm)	Newtons	Ref. Ref.	A (mm)	B (mm)	C (mm)	D (mm)	Newtons
70/870-515	205	104	8	8	100	70/870-533	500	260	8	8	230
70/870-516	205	105	8	8	500	70/870-534	501	253	8	8	200
70/870-517	250	120	8	8	330	70/870-535	501	260	8	8	200
70/870-632	274	132	8	8	150	70/870-536	502	265	8	8	200
70/870-518	278	135	8	8	200	70/870-537	512	253	8	8	350
70/870-633	315	151	8	8	150	70/870-538	525	255	8	8	190
70/870-519	316	168	8	8	280	70/870-634	525	259	8	8	600
70/870-520	325	163	8	8	200	70/870-540	540	277	8	8	140
70/870-521	365	180	8	8	200	70/870-541	584	295	8	8	100
70/870-522	375	185	8	8	180	70/870-542	585	290	8	8	200
70/870-523	395	200	8	8	150	70/870-543	585	292	8	8	150
70/870-524	400	193	8	8	250	70/870-635	585	292	8	8	500
70/870-525	400	210	8	8	370	70/870-636	585	292	8	8	600
70/870-526	483	240	8	8	100	70/870-544	592	301	8	8	220
70/870-527	485	240	8	8	200	70/870-545	600	310	8	8	150
70/870-528	485	246	8	8	175	70/870-546	640	346	8	8	100
70/870-529	490	246	8	8	100	70/870-547	736	368	8	8	170
70/870-530	497	260	8	8	200	70/870-548	786	398	8	8	190
70/870-531	500	260	8	8	210	70/870-637	885	447	8	8	500
70/870-532	500	260	8	8	220	70/870-638	885	447	8	8	800

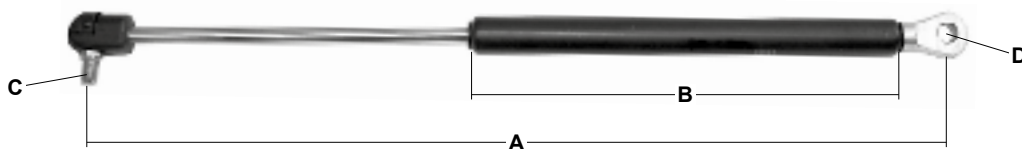

Ref. Ref.	A (mm)	B (mm)	C (mm)	D (mm)	Newtons	Ref. Ref.	A (mm)	B (mm)	C (mm)	D (mm)	Newtons
70/870-549	318	152	8	8	170	70/870-552	500	242	8	8	170
70/870-550	323	156	8	8	100	70/870-553	500	242	8	8	200
70/870-551	402	197	8	8	150						

Part numbers are quoted for reference purposes only.  
Our parts and accessories are not original.

Las referencias originales tienen un propósito identificativo.  
Nuestras piezas no son originales.



"THE RELIABLE SERVICE"



**GAZ STRUTS**  
**AMORTIGUADORES**

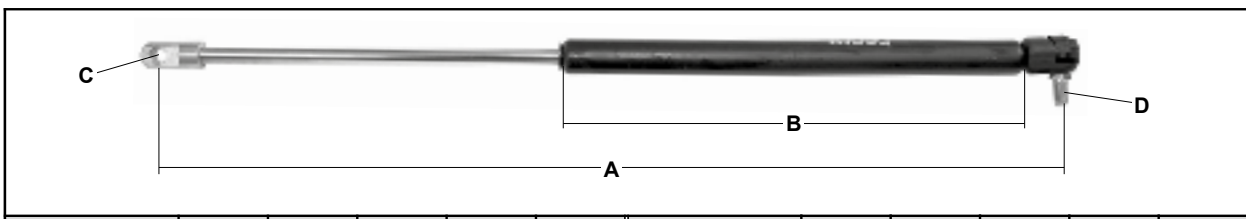

Ref. Ref.	A (mm)	B (mm)	C (mm)	D (mm)	Newtons	Ref. Ref.	A (mm)	B (mm)	C (mm)	D (mm)	Newtons
70/870-554	450	227	8	8	150						

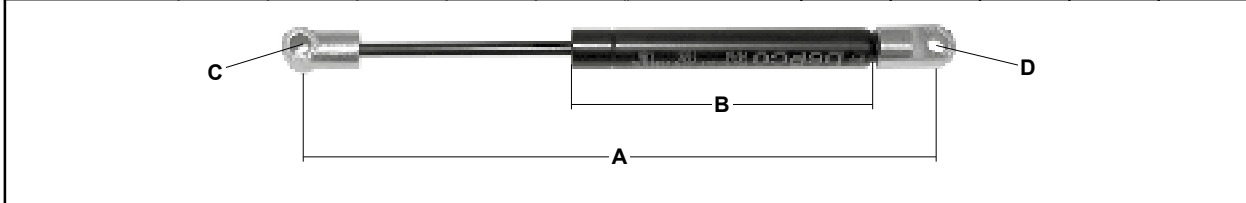

Ref. Ref.	A (mm)	B (mm)	C (mm)	D (mm)	Newtons	Ref. Ref.	A (mm)	B (mm)	C (mm)	D (mm)	Newtons
70/870-555	215	105	8	8	1100	70/870-639	500	258	10	10	2100
70/870-556	237	112	8	8	135						

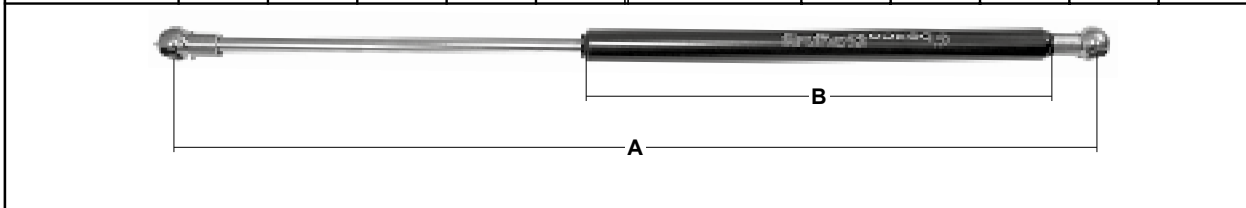

Ref. Ref.	A (mm)	B (mm)	C (mm)	D (mm)	Newtons	Ref. Ref.	A (mm)	B (mm)	C (mm)	D (mm)	Newtons
70/870-557	215	100	-	-	410	70/870-561	390	193	-	-	570
70/870-558	250	123	-	-	350	70/870-562	500	350	-	-	200
70/870-559	260	130	-	-	250	70/870-563	500	350	-	-	300
70/870-640	278	135	-	-	200	70/870-564	505	250	-	-	220
70/870-560	330	160	-	-	278						

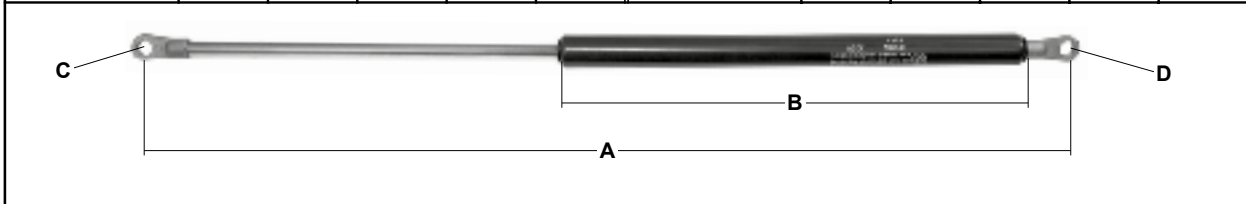

Ref. Ref.	A (mm)	B (mm)	C (mm)	D (mm)	Newtons	Ref. Ref.	A (mm)	B (mm)	C (mm)	D (mm)	Newtons
70/870-565	420	220	10	10	200	70/870-641	500	245	8	8	300
70/870-566	490	235	8	8	400	70/870-569	504	253	8	8	150
70/870-567	490	240	8	8	210	70/870-570	590	290	8	8	400
70/870-568	498	247	8	8	230						

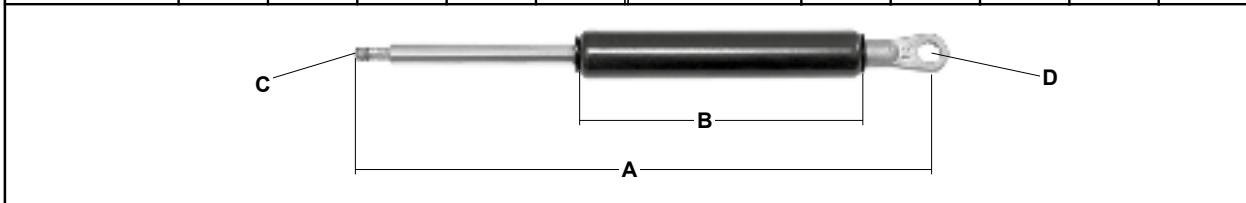

Ref. Ref.	A (mm)	B (mm)	C (mm)	D (mm)	Newtons	Ref. Ref.	A (mm)	B (mm)	C (mm)	D (mm)	Newtons
70/870-571	215	105	6	8	200	70/870-572	430	265	8	8	985
70/870-642	215	105	6	8	300						

Part numbers are quoted for reference purposes only.  
Our parts and accessories are not original.

Las referencias originales tienen un propósito identificativo.  
Nuestras piezas no son originales.



**"THE RELIABLE SERVICE"**





GAZ STRUTS  
AMORTIGUADORES

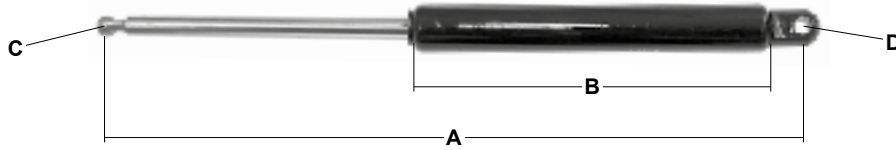

Ref. Ref.	A (mm)	B (mm)	C (mm)	D (mm)	Newtons	Ref. Ref.	A (mm)	B (mm)	C (mm)	D (mm)	Newtons
70/870-573	260	130	8	6	120						

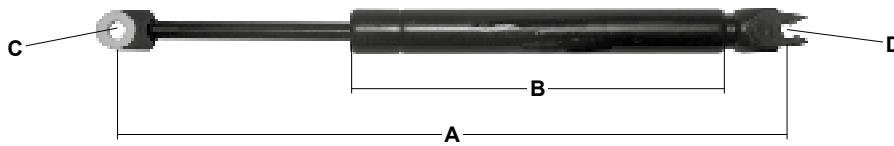

Ref. Ref.	A (mm)	B (mm)	C (mm)	D (mm)	Newtons	Ref. Ref.	A (mm)	B (mm)	C (mm)	D (mm)	Newtons
70/870-574	215	126	6	6	120						

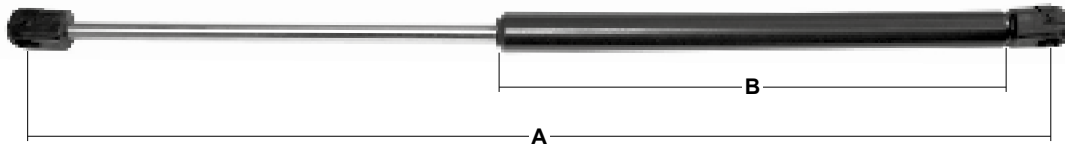

Ref. Ref.	A (mm)	B (mm)	C (mm)	D (mm)	Newtons	Ref. Ref.	A (mm)	B (mm)	C (mm)	D (mm)	Newtons
70/870-575	227	110	-	-	600	70/870-584	487	240	-	-	200
70/870-576	235	120	-	-	750	70/870-585	500	250	-	-	200
70/870-577	252	130	-	-	250	70/870-586	500	252	-	-	150
70/870-578	276	138	-	-	100	70/870-587	505	255	-	-	230
70/870-643	277	140	-	-	150	70/870-588	520	260	-	-	200
70/870-579	305	160	-	-	142	70/870-589	535	270	-	-	180
70/870-580	325	162	-	-	200	70/870-590	600	300	-	-	250
70/870-581	325	164	-	-	250	70/870-591	630	315	-	-	250
70/870-582	405	205	-	-	200	70/870-592	637	345	-	-	200
70/870-583	478	235	-	-	150	70/870-593	700	444	-	-	350

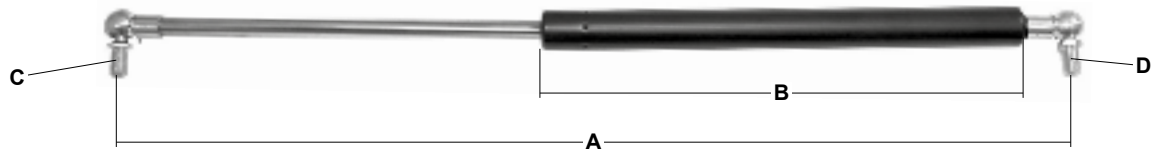

Ref. Ref.	A (mm)	B (mm)	C (mm)	D (mm)	Newtons	Ref. Ref.	A (mm)	B (mm)	C (mm)	D (mm)	Newtons
70/870-594	183	93	8	8	150	70/870-603	422	210	8	8	135
70/870-595	200	95	8	8	400	70/870-604	495	250	8	8	210
70/870-596	239	117	8	8	150	70/870-605	500	240	8	8	150
70/870-597	240	118	8	8	340	70/870-606	500	245	8	8	130
70/870-598	240	122	8	8	220	70/870-607	505	240	8	8	200
70/870-599	278	125	8	8	330	70/870-608	505	270	10	10	530
70/870-600	280	125	8	8	320	70/870-609	550	270	8	8	180
70/870-601	340	168	8	8	100	70/870-610	595	300	8	8	100
70/870-602	340	168	8	8	250	70/870-611	605	287	8	8	150
70/870-644	410	205	8	8	200	70/870-612	611	345	8	8	100

Part numbers are quoted for reference purposes only.  
Our parts and accessories are not original.

Las referencias originales tienen un propósito identificativo.  
Nuestras piezas no son originales.



"THE RELIABLE SERVICE"



**GAZ STRUTS  
AMORTIGUADORES**

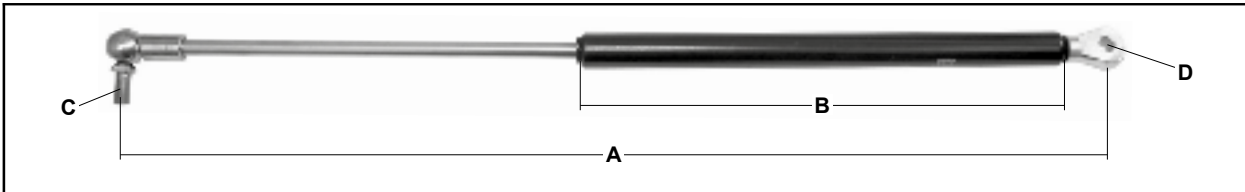

Ref. Ref.	A (mm)	B (mm)	C (mm)	D (mm)	Newtons	Ref. Ref.	A (mm)	B (mm)	C (mm)	D (mm)	Newtons
--------------	-----------	-----------	-----------	-----------	---------	--------------	-----------	-----------	-----------	-----------	---------

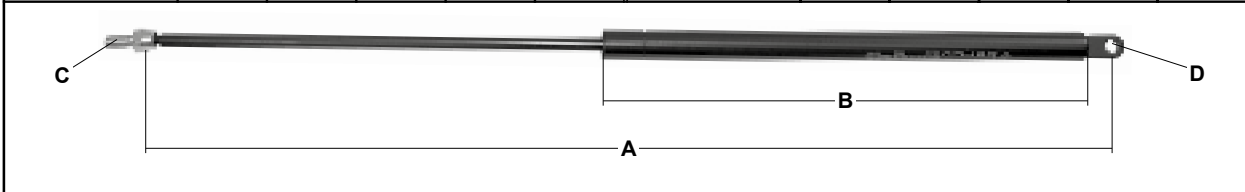

70/870-613	500	248	8	8	180						
------------	-----	-----	---	---	-----	--	--	--	--	--	--

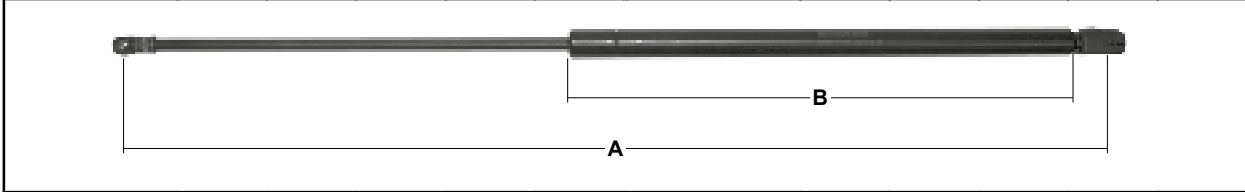

70/870-645	380	200	8	8	400	70/870-614	575	294	8	6	150
------------	-----	-----	---	---	-----	------------	-----	-----	---	---	-----

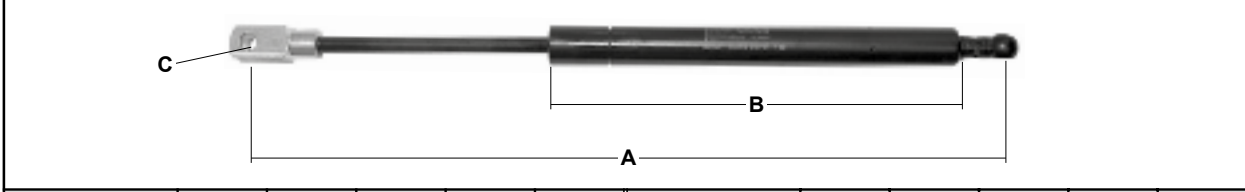

70/870-615	590	300	-	-	530						
------------	-----	-----	---	---	-----	--	--	--	--	--	--

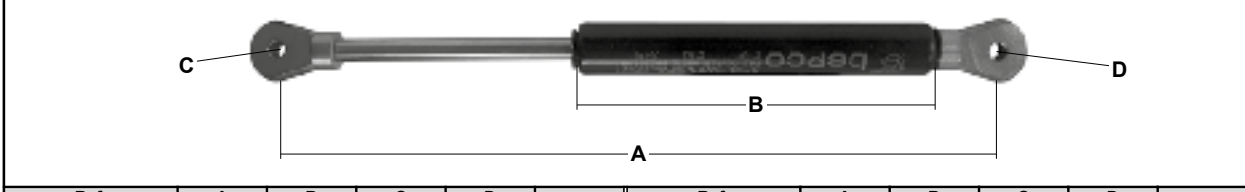

70/870-616	354	193	8	-	900						
------------	-----	-----	---	---	-----	--	--	--	--	--	--

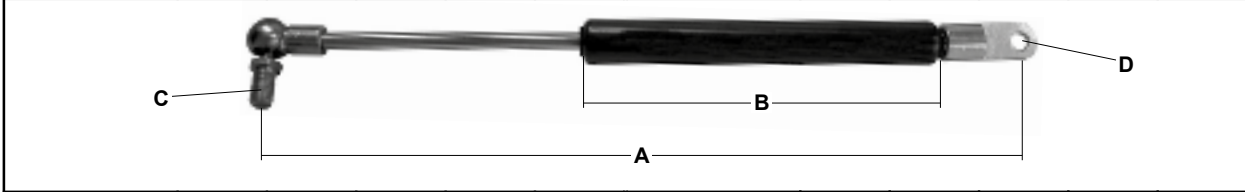

70/870-617	245	120	6	6	210	70/870-620	500	265	8	8	960
70/870-618	285	138	10	10	520	70/870-646	887	445	8	8	600
70/870-619	313	161	8	8	150	70/870-647	887	445	8	8	800

Part numbers are quoted for reference purposes only.  
Our parts and accessories are not original.

*Las referencias originales tienen un propósito identificativo.  
Nuestras piezas no son originales.*

**"THE RELIABLE SERVICE"**

GAZ STRUTS  
AMORTIGUADORES



BALL JOINTS / RÓTULAS

Fig. Fig.	Ref. Ref.	Type Type	A (mm)	B (mm)	C (mm)	D (mm)	E (mm)	F (mm)
	70/877-1	RA	M5	M5	10.0	-	20.0	-
	70/877-2	RA	M6	M6	14.0	-	25.0	-
	70/877-3	RA	M8	M8	16.0	-	30.0	-
	70/877-4	RA	M10	M10	20.0	-	35.0	-
	70/877-22	RA	M6	M8	13.0	-	20.0	-
	70/877-5	RA	M5	M8	11.0	-	30.0	-
	70/877-6	RA	M8	M8	14.0	-	30.0	-
	70/877-7	RA	M8	M8	10.0	-	20.0	-
	70/877-8	RP	M6	M8	13.0	-	18.0	-
	70/877-9	RP	M6	M8	13.0	-	25.0	-
	70/877-10	P(P)	M5	-	-	6.2	16.0	11.0
	70/877-11	P(P)	M6	-	-	6.2	20.0	13.0
	70/877-12	P(P)	M6	-	-	8.2	22.0	13.0
	70/877-13	P(G)	M6	-	-	6.1	21.0	21.5
	70/877-14	P(G)	M6	-	-	8.1	21.0	21.5
	70/877-15	P(G)	M6	-	-	10.1	29.0	21.5
	70/877-16	AV	M6	-	-	6.1	27.5	13.0
	70/877-17	AV	M8	-	-	8.2	30.5	18.0
	70/877-18	AV	M5	-	-	6.2	25.0	13.0
	70/877-19	-	M8	8.0	-	9.0	32.0	16.0
	70/877-20	-	M10	10.0	-	10.2	40.0	20.0
	70/877-21	-	M10	-	-	8.2	25.0	17.0

RA - AV Steel - Acero  
P(P) Little model - Poco modelo

RP Plastic - Plastico  
P(G) Big model - Modelo grande

Part numbers are quoted for reference purposes only.  
Our parts and accessories are not original.

Las referencias originales tienen un propósito identificativo.  
Nuestras piezas no son originales.



## ACCESSORIES CAB PARTS

**ECHELLE (3 MARCHES) - LADDER (3 STEPS) - LEITER (3 STUFIG) -  
TRAP (3 TREDEN) - ESCALERA (3 ESCALONES)**

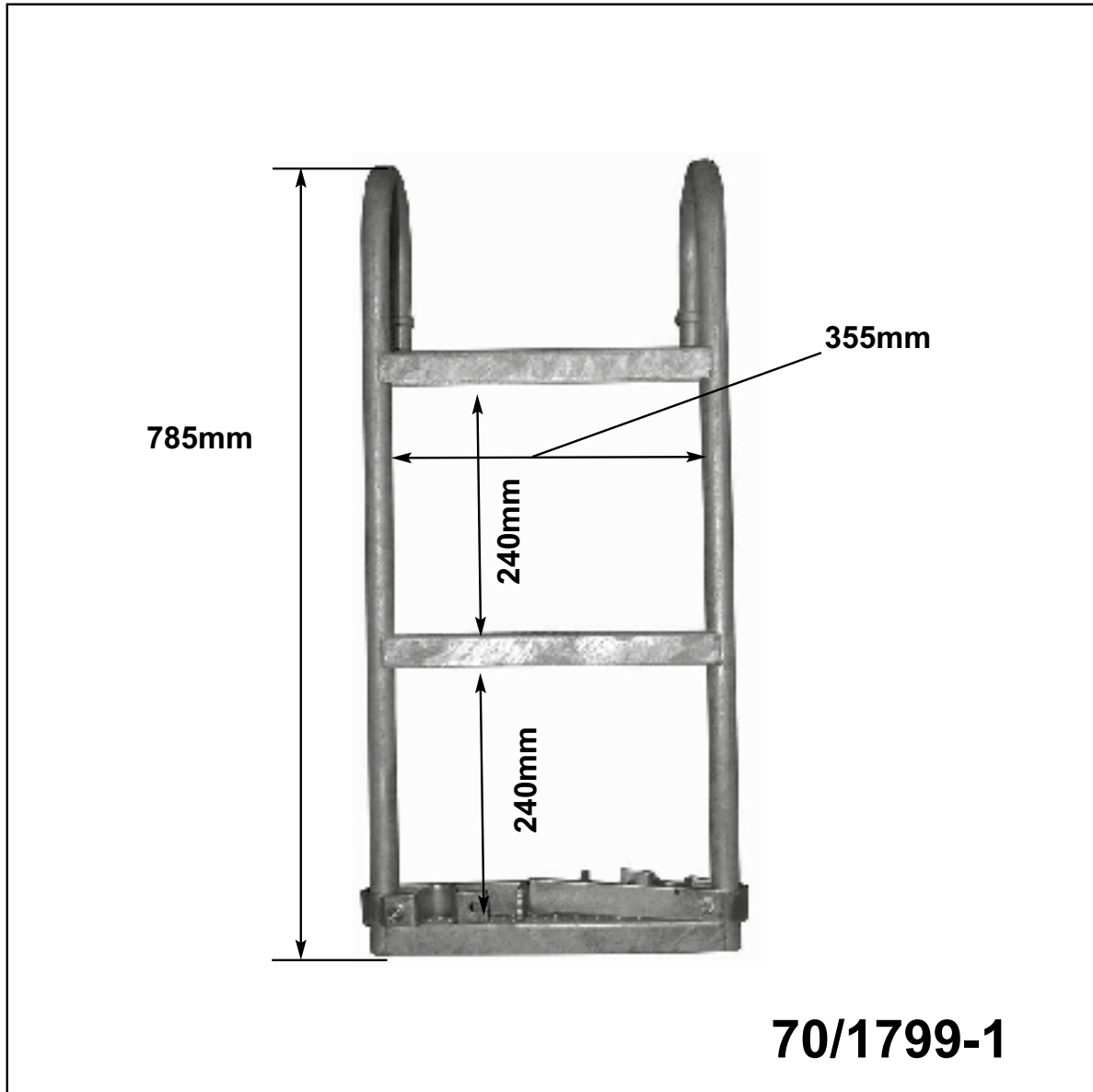

Les références des pièces sont indicatives.  
Nos pièces ne sont pas d'origine.

Part numbers are quoted for reference purposes only.  
Our parts and accessories are not original.



**"THE RELIABLE SERVICE"**



## ACCESSORIES

**Garde-boue pour roues avant - Fenders for front wheels - Kunststoff-kotflügel - Spatborden voor voorwielen (Vervolg) - Guardabarros (ruedas delanteras)**

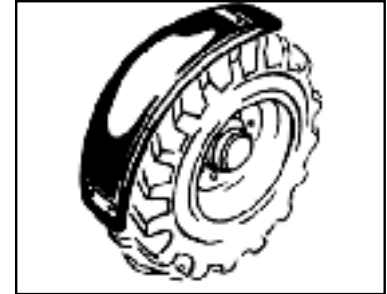
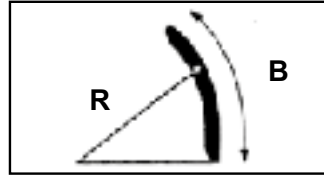
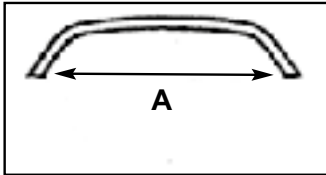

**Prix compétitifs - Competitive prices - Konkurrenzfähige Preise - Competitieve prijzen - Precios competitivos**

Dimensions de pneu - Tyres size - Masse Reifen - Afmetingen banden - Dimensión de neumáticos	Ref.	A (mm)	B (mm)	R (mm)
4.00-15, 5.00-15, 4.50-16, 5.00-16, 5.50-16, 6.00-16, 4.00-19, 4.50-19, 6.00-19	70/844-46	180	700	440
7.50-16, 6.50-16, 7.00-16, 7.50-16, 7.50-18, 6.00-20, 6.50-20, 7.3-24	70/844-47	230	800	480
6.50-20, 7.50-20, 8.00-20, 7.3-24	70/844-48	250	920	525
9.5-20, 8.3-24, 9.5-24, 8.3-28, 9.5-28	70/844-49	265	1000	615
	70/844-50	300	950	590
9.00-16, 10.00-16, 10.5-18, 10.5-20, 11.2-20, 275/80-R20, 11.2-24, 11.2-28, 12.5/80-18, 12.4-28, 275/80-R18	70/844-51	320	1070	640
12.4-24, 11.2-32, 320/70-R28	70/844-52	330	1180	720
11.00-16, 12.5-18, 335/80-R18, 11.4-20, 12.5-20, 335/80-R20, 12.4-24, 320/70-R24, 360/70-R24.	70/844-53	350	1090	650
13.6-24, 12.4-28, 320/70-R28, 12.4-32, 14.5-20, 13.6-28	70/844-54	370	1280	720
405/70-R20, 380/70-R24, 14.9-28, 380/70-R28	70/844-55	420	1200	725
425/75-R20, 16.9-24, 420/70-R24, 445/70-R24, 16.9-26, 480/70-R26, 420/70-R28, 480/70-R28, 420/70-R30, 16.9-28, 14.9-28, 11.2-32	70/844-56	470	1330	790
	70/844-57	470	2200	964
19.5-24, 19.5-28, 18.4-26, 480/70-R26, 480/70-R28, 480/70-R30, 18.4-30, 18.4-34.	70/844-58	540	1540	810
	70/844-59	550	2200	964
	70/844-60	620	1900	900
405/70-R20, 600/65-R28, 620/70-R26	70/844-61	620	1560	810

Les références des pièces sont indicatives.  
Nos pièces ne sont pas d'origine.

Part numbers are quoted for reference purposes only.  
Our parts and accessories are not original.



**"THE RELIABLE SERVICE"**



## ACCESSORIES CAB PARTS

Porte-document - Document case - Dokumentenbox -  
Dokumentenkuoffer - Portafolios

**70/1563-13**

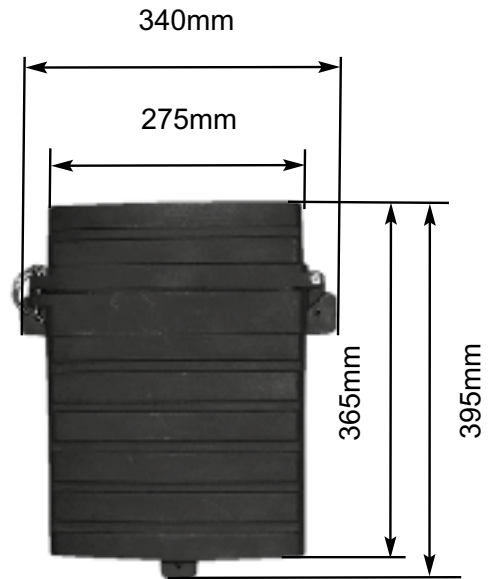

Les références des pièces sont indicatives.  
Nos pièces ne sont pas d'origine.

Part numbers are quoted for reference purposes only.  
Our parts and accessories are not original.



**"THE RELIABLE SERVICE"**





## ACCESSORIES

Ecrou d'accouplement - Tie rod end nut - Mutter für Axialgelenk -  
Moer voor aankoppeling - Tuerca para el acoplamiento

Part N°	Filetage Thread Gewinde Draad Rosca	
70/2310-25	M18x1,5D	
70/2310-26	M18x1,5G	
70/2310-27	M20x1,5D	
70/2310-28	M22x1,5D	
70/2310-29	M24x1,5D	
70/2310-30	M24x1,5G	

Les références des pièces sont indicatives.  
Nos pièces ne sont pas d'origine.

Part numbers are quoted for reference purposes only.  
Our parts and accessories are not original.



## ACCESSORIES

Colliers d'échappement universel M8 (Acier zingué)  
Exhaust clamps M8 universal (Iron galvanized)  
Rohrschellen M8 Universal (Eisen glanzverzinkt)  
Uitlaatklemmen M8 universeel (Ijzer gegalvaniseerd)  
Abrazaderas universal M8 (Acero galvanizado)

Part N°	Dimension Size Mass Afmeting Dimensión	
70/2935-40	40mm	
70/2935-42	42mm	
70/2935-45	45mm	
70/2935-48	48mm	
70/2935-50	50mm	
70/2935-52	52mm	
70/2935-54	54mm	
70/2935-58	58mm	
70/2935-60	60mm	
70/2935-65	65mm	
70/2935-67	67mm	
70/2935-70	70mm	
70/2935-73	73mm	
70/2935-75	75mm	
70/2935-79	80mm	
70/2935-83	83mm	
70/2935-90	90mm	
70/2935-95	95mm	
70/2935-102	102mm	
70/2935-106	106mm	
70/2935-110	110mm	
70/2935-115	115mm	
70/2935-120	120mm	
70/2935-127	127mm	

Les références des pièces sont indicatives.  
Nos pièces ne sont pas d'origine.

Part numbers are quoted for reference purposes only.  
Our parts and accessories are not original.



## ACCESSORIES CAB PARTS

Câbles d'arrêt - Stop cables - Stoppzûg - Motorstopkabels - Cables de paro



	Parts N°	Longueur A - Lenght A Länge A - Lengte A Longitud A
Câble à recouper / Cable to cut Bowdengzug (universal) / Kabel in te korten Cables para cortar	70/107-2	2000mm
	70/107-23	4000mm



Les références des pièces sont indicatives.  
Nos pièces ne sont pas d'origine.

Part numbers are quoted for reference purposes only.  
Our parts and accessories are not original.



## CAB PARTS

**Ceinture de sécurité (Standard) - Standard seat belt -  
Standard Sicherheitsgurt - Standaard veiligheids gordel - Cinturon estándar**

	N° Parts	Description - Beschreibung - Omschrijving - Descripción
	61/828-1	Avec dérouleur - With holder - Mit Ausleger - met afroller - Con desenrollador
	61/828-2	Fixe - Fixed - Fest - Vast - Fijo

Les références des pièces sont indicatives.  
Nos pièces ne sont pas d'origine.

Part numbers are quoted for reference purposes only.  
Our parts and accessories are not original.



## CAB PARTS

### Aménagement intérieur - Interior trim - Innenausstattung - Binnenbekleidung - Forro de cabina



Fig.	Part N°	Description - Description - Beschreibung - Omschrijving - Descripción	Spécification - Specification - Spezifikation - Specificatie - Especificación
1	70/4158-1	Gris - Grey - Grau - Grijs - Gris	2m x 1.2mm x 12mm Ep. / Tck. / T. / D. / Gr.
	70/4158-5	Gris - Grey - Grau - Grijs - Gris	2m x 1.2m x 24mm Ep. / Tck. / T. / D. / Gr.
	70/4158-2	Brun -Brown - Braun - Bruin - Marron	2m x 1.2mm x 12mm Ep. / Tck. / T. / D. / Gr.
	70/4158-6	Brun -Brown - Braun - Bruin - Marron	2m x 1.2m x 24mm Ep. / Tck. / T. / D. / Gr.
	70/4160-2	Noir - Black - Schwarz - Zwart - Negro	2m x 1.2mm x 12mm Ep. / Tck. / T. / D. / Gr.
	70/4158-7	Noir - Black - Schwarz - Zwart - Negro	2m x 1.2m x 24mm Ep. / Tck. / T. / D. / Gr.
	70/4158-4	Bleu - Blue - Blau - Blauw - Azul	2m x 1.2mm x 12mm Ep. / Tck. / T. / D. / Gr.
	70/4158-8	Bleu - Blue - Blau - Blauw - Azul	2m x 1.2m x 24mm Ep. / Tck. / T. / D. / Gr.
2	70/4160-1	Spray adhesif - Spray adhesive - Haftspray - Lijn-spray - Adesivo en spray	Aérosol 500ml -Aerosol 500ml - Aerosol 500ml Aerosol 500ml - Aerosol 500ml

Les références des pièces sont indicatives.  
Nos pièces ne sont pas d'origine.

Part numbers are quoted for reference purposes only.  
Our parts and accessories are not original.



## CAB PARTS

Rétroviseur d'intérieur de cabine - Inner cab mirror - Binnenspiegel -  
Innenrückspiegel von Kabine - Retrovisor interior de cabina



Part N°	H x L
70/4172-180	155 x 235 mm

Les références des pièces sont indicatives.  
Nos pièces ne sont pas d'origine.

Part numbers are quoted for reference purposes only.  
Our parts and accessories are not original.



**"THE RELIABLE SERVICE"**





## CAB PARTS

Bras de rétroviseur - Arm - Spiegelsteun - Spiegel - Brazo retrovisor

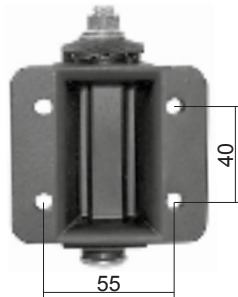

**70/4172-142** (Droit - RH - Rechts - Rechts - Derecha)  
**70/4172-143** (Gauche - LH - Links - Links - Izquierda)

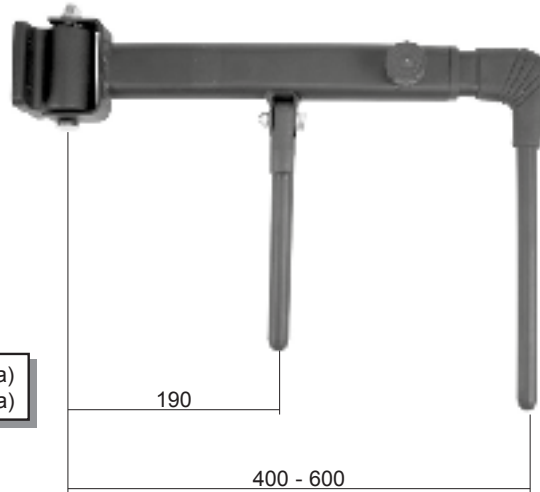

Support gyrophare - Rotating light bracket - Zwaailampsteun -  
Kontakstecker für Rundkennleuchte - Soporte faro rotativo

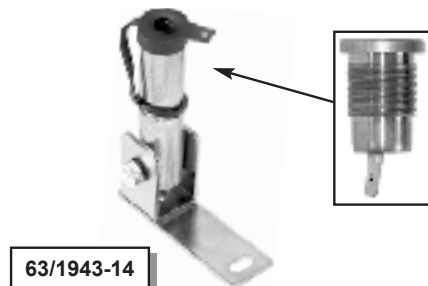
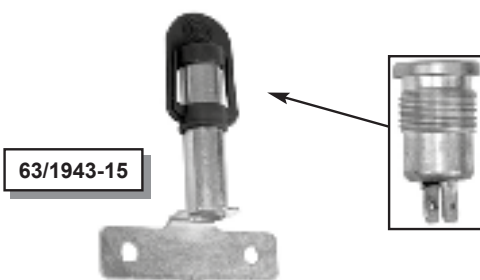

Boule de volant - Steering knob - Stuurknop - Runder Knopf - Bola de volante



**RETROVISEURS**  
**MIRRORS**

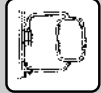

**70/4172-40**

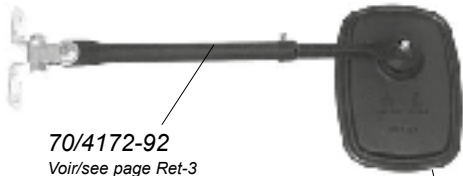

70/4172-92  
Voir/see page Ret-3

70/4172-15

**70/4172-1**

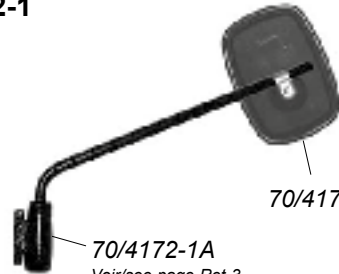

70/4172-15

70/4172-1A  
Voir/see page Ret-3

**70/4172-99**

Droit-Right

**70/4172-100**

Gauche-Left



70/4172-52

**70/4172-50**

Droit-Right

**70/4172-51**

Gauche-Left



70/4172-52

**70/4172-6**



70/4172-8  
Voir/see page Ret-3

70/4172-5

**70/4172-175**

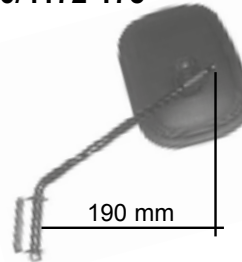

190 mm

- Corps plastique / Plastic body
- Homologué / Certified E.9
- Dimensions : 190x140 mm
- Fixation : 2x Ø 6 mm

**70/4172-15**



- Corps plastique / Plastic body
- Homologué / Certified E.11
- Dimensions : 177x125 mm
- Fixation : Ø 13-16 mm
- Glace/Glass : 70/4172-15G

**70/4172-18**



- Vue grand angle / Wide angle
- Corps plastique / Plastic body
- Homologué / Certified E.11
- Dimensions : 183x131 mm
- Fixation : Ø 13/16 mm
- Glace/Glass : 70/4172-18G

**70/4172-78**



- Vue grand angle / Wide angle
- Corps métallique / Steel body
- Dimensions : 200x130 mm
- Fixation : Ø 10/12 mm

**70/4172-72**



- Vue grand angle / Wide angle
- Corps métallique / Steel body
- Homologué / Certified E.11
- Dimensions : 226x165 mm
- Fixation : Ø 12/18 mm





## RETROVISEURS MIRRORS

**70/4172-52**



Corps plastique / Plastic body  
 Homologué / Certified E.11  
Dimensions :  
 235x175 mm  
Fixation :  
 Ø 20 mm

Montage italien  
Italian fitting

**70/4172-5**



Corps métallique / Steel body  
 Homologué / Certified E.11  
Dimensions :  
 242x163 mm  
Fixation :  
 Ø 15/17 mm

**70/4172-80**



Corps métallique / Steel body  
Dimensions :  
 245x140 mm  
Fixation :  
 Ø 10/12 mm

**70/4172-27**



Vue grand angle / Wide angle  
 Corps plastique / Plastic body  
Dimensions :  
 245x155 mm  
Fixation :  
 M16  
Série/Serie :  
 CASE-IH : (XL, XLA)  
 Replace : 3399576R9

**70/4172-19**



Vue grand angle / Wide angle  
 Corps plastique / Plastic body  
 Homologué / Certified E.11  
Dimensions :  
 253x153 mm  
Fixation :  
 Ø 13/16 mm  
Glace/Glass :  
 70/4172-19G

**70/4172-81**



Corps plastique / Plastic body  
 Homologué / Certified E.11  
Dimensions :  
 258x150 mm  
Fixation :  
 Ø 10 mm

**70/4172-16**



Corps plastique / Plastic body  
 Homologué / Certified E.11  
Dimensions :  
 250x160 mm  
Fixation :  
 Ø 13/16 mm  
Glace/Glass :  
 70/4172-16G

**70/4172-71**



Vue grand angle / Wide angle  
 Corps plastique / Plastic body  
 Homologué / Certified E.11  
Dimensions :  
 265x165 mm  
Fixation :  
 Ø 12/15 mm  
Glace/Glass :  
 70/4172-101  
 70/4172-102 (Grand angle/  
 wide angle)

**70/4172-30**



Vue grand angle / Wide angle  
 Corps métallique / Steel body  
Dimensions :  
 300x210 mm  
Fixation :  
 Ø 15/18 mm  
Série/Serie :  
 Deutz  
 (Remplace / Replace  
 04304841)

**70/4172-17**



Corps métallique / Steel body  
 Homologué / Certified E.11  
Dimensions :  
 300x210 mm  
Fixation :  
 Ø 16/22 mm  
Glace/Glass :  
 70/4172-17G



"THE RELIABLE SERVICE"



**RETROVISEURS  
MIRRORS**

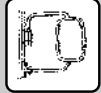

**70/4172-20**



Vue grand angle / Wide angle  
 Corps plastique / Plastic body  
 Homologué / Certified E.11  
**Dimensions :**  
 318x220 mm  
**Fixation :**  
 Ø 16/22 mm  
**Glace/Glass :**  
 70/4172-20G

**70/4172-85**



Vue grand angle / Wide angle  
 Corps plastique / Plastic body  
 Homologué / Certified E.11  
**Dimensions :**  
 345x200 mm  
**Fixation :**  
 Ø 15/18 mm

**70/4172-86**



Corps métallique / Steel body  
 Homologué / Certified E.3  
**Dimensions :**  
 354x169 mm  
**Fixation :**  
 Ø 19 mm  
  
 Montage italien  
 Italian fitting

**70/4172-87**



Corps plastique / Plastic body  
 Homologué / Certified E.3  
**Dimensions :**  
 370x186 mm  
**Fixation :**  
 18 mm

**70/4172-88**

*Droit - right*

**70/4172-89**

*Gauche - left*

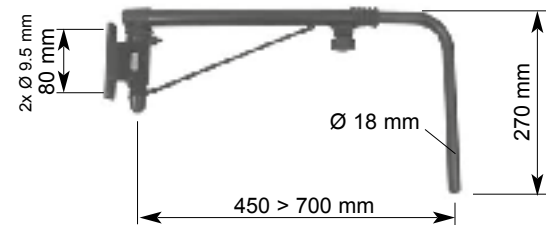

**70/4172-1A**

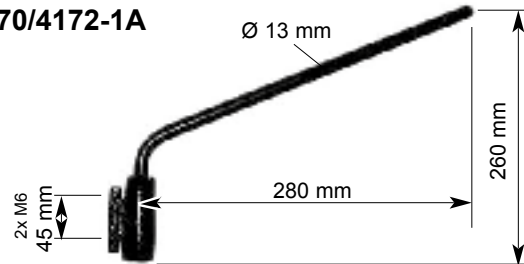

**70/4172-91**

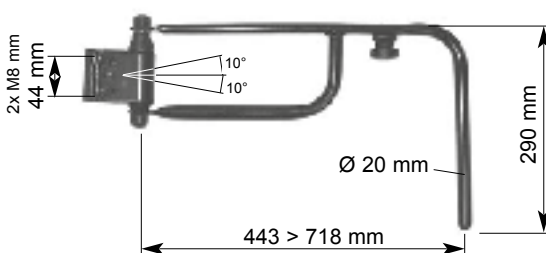

**70/4172-92**

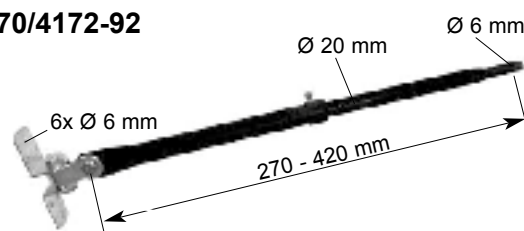

**70/4172-93**



**Plaque d'adaptation**  
**Fitting plate**  
 Pour/for 70/4172-91

**70/4172-93 :**  
 (2 trous/2 holes), ép./thick.: 8 mm  
**70/4172-94 :**  
 (4 trous/4 holes), ép./thick.: 20 mm

**70/4172-94**



**70/4172-8**

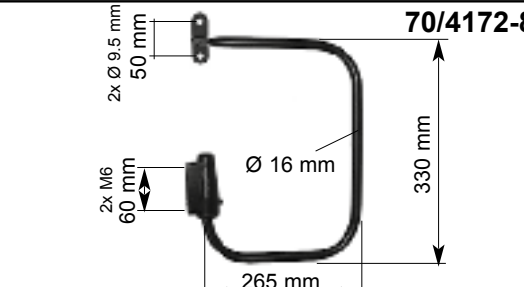



**RETROVISEURS**  
**MIRRORS**



**70/4172-95**

Ø 15 > 25 mm



**70/4172-96**

Ø 12 > 15 mm

**70/4172-97**

Ø 15 > 17 mm

**70/4172-98**

Ø 17 > 19 mm

**Cross Référence / Cross reference**

**Ancienne réf**

**Old ref.**

10/390  
10/50006  
10/5118  
10/5191  
10/5192  
10/51921  
10/5417  
10/5419  
10/6100K  
10/6217  
10/6218E  
10/6219E  
10/6220  
10/6226E  
10/6227E  
10/6228E  
10/6229E  
10/6230  
10/6231E  
10/6245  
10/6246  
10/6247  
10/6248  
10/6356  
10/6357  
10/721  
10/722  
28/4172-42  
28/4172-43  
29/9234-147  
29/9234-149  
31/L1427/251  
31/L3301/568  
4172-15G  
4172-16G  
4172-17G  
4172-18G  
4172-19G  
4172-20G  
ET.120  
ET.120/ARM  
ET.4161  
ET.642  
ET.642/3  
New  
New

**Nouvelle réf.**

**New ref.**

70/4172-30  
70/4172-101  
70/4172-81  
70/4172-71  
70/4172-85  
70/4172-102  
70/4172-27  
70/4172-87  
70/4172-91  
70/4172-78  
70/4172-15  
70/4172-18  
70/4172-80  
70/4172-5  
70/4172-16  
70/4172-19  
70/4172-17  
70/4172-72  
70/4172-20  
70/4176-96  
70/4172-97  
70/4172-98  
70/4172-95  
70/4172-93  
70/4172-94  
70/4172-50  
70/4172-51  
70/4172-88  
70/4172-89  
70/4172-99  
70/4172-100  
70/4172-86  
70/4172-52  
70/4172-15G  
70/4172-16G  
70/4172-17G  
70/4172-18G  
70/4172-19G  
70/4172-20G  
70/4172-40  
70/4172-92  
70/4172-8  
70/4172-1  
70/4172-1A  
70/4172-6  
70/4172-175

**Nouvelle réf.**

**New ref.**

70/4172-100  
70/4172-1  
70/4172-101  
70/4172-102  
70/4172-15  
70/4172-15G  
70/4172-16  
70/4172-16G  
70/4172-17  
70/4172-17G  
70/4172-18  
70/4172-18G  
70/4172-19  
70/4172-19G  
70/4172-80  
70/4172-20  
70/4172-20G  
70/4172-27  
70/4172-30  
70/4172-40  
70/4172-5  
70/4172-50  
70/4172-51  
70/4172-52  
70/4172-6  
70/4172-71  
70/4172-72  
70/4172-78  
70/4172-8  
70/4172-81  
70/4172-85  
70/4172-86  
70/4172-87  
70/4172-88  
70/4172-89  
70/4172-1A  
70/4172-91  
70/4172-92  
70/4172-93  
70/4172-94  
70/4172-95  
70/4172-97  
70/4172-98  
70/4172-99  
70/4176-96  
70/4172-175

**Ancienne réf**

**Old ref.**

29/9234-149  
ET.642  
10/50006  
10/51921  
10/6218E  
4172-15G  
10/6227E  
4172-16G  
10/6229E  
4172-17G  
10/6219E  
4172-18G  
10/6228E  
4172-19G  
10/6220  
10/6231E  
4172-20G  
10/5417  
10/390  
ET.120  
10/6226E  
10/721  
10/722  
31/L3301/568  
New  
10/5191  
10/6230  
10/6217  
ET.4161  
10/5118  
10/5192  
31/L1427/251  
10/5419  
28/4172-42  
28/4172-43  
ET.642/3  
10/6100K  
ET.120/ARM  
10/6356  
10/6357  
10/6248  
10/6246  
10/6247  
29/9234-147  
10/6245  
New



**"THE RELIABLE SERVICE"**



- 11 -

**ACCESORIOS DIVERS**

POUR MANOEUVRER RAPIDEMENT ET EN TOUTE SECURITE  
TOUS ENGINs INDUSTRIELS, AGRICOLES OU DE GENIE CIVIL,  
VOICI LA FAMILLE

**AGROPA**

FABRICATION  
ALLEMANDE

8 POIGNETS DE CONDUITE ADAPTABLES A TOUS LES VOLANTS.  
CONÇUS POUR RENDRE TOUTES LES EXIGENCES . . .



**NORMAL et SUPER**



**ELASTIC**



**UNIVERSAL**



**OPTIMAL**

- A.105 - AGROPA "NORMAL" - Pompeau autolubrifié, inclinable, pour volants évasés à 15°.
- A.106 - AGROPA "NORMAL" - Pompeau autolubrifié, inclinable, pour volants évasés à 30°.
- A.93 - AGROPA "SUPER" - Pompeau sphérique sur roulement à billes, pour volants évasés à 15°.
- A.94 - AGROPA "SUPER" - Idem, pour volants évasés à 30°.
- A.95 - AGROPA "ELASTIC" - Avec large pompeau en caoutchouc, recommandée pour engins sans direction assistée, pour volants évasés à 15°.
- A.96 - AGROPA "ELASTIC" - Idem, pour volants évasés à 30°.
- A.97 - AGROPA "UNIVERSAL" - Nouveau modèle universel pour installation indépendante de la branche du volant.
- A.98 - AGROPA "OPTIMAL" - Modèle spécial pour montage sur volants à branches larges (maximum 60 mm.)

**POIGNETS DE CONDUITE "PRIX BUDGET"**



Pour un prix attractif, poignets de fabrication robuste, adaptables à tous volants.

REF.	CARACTERISTIQUES
A.107	Pour volants normaux 15°
A.108	Pour volants évasés 30°

**ATTACHES POUR CAPOTS**

modèles standard en caoutchouc spécial.  
Parties métalliques rigides.

- A.20 - Modèle long (123 mm.)
- A.19 - Caoutchouc seul
- A.20/C - Modèle court (63 mm.)

**COFFRES A OUTILS ADAPTABLES  
A TOUS TRACTEURS**

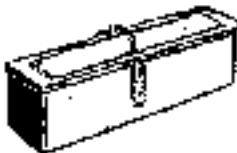

**FILTRES A AIR  
POUR CABINES**

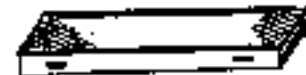

- B54R/VE - Grand coffre 420x115x112 mm. avec poignée.
- B54S - Coffre normal 260x100x100 mm. (convient également pour accessoires de secours.)

- ML.238 - 435 x 150 x 55 mm.
  - ML.237 - 675 x 130 x 55 mm.
  - ML.239 - 720 x 158 x 55 mm.
  - ML.235 - 800 x 198 x 55 mm. - Fiat-Agni
  - ML.241 - 960 x 154 x 55 mm. - New-Holland TF.44
- Selon applications

**"Un service sûr"**

2/8000



FASCICULO 1 SUPPLEMENT

Page 2/2000

ACCESSOIRES ET RECHANGES POUR CABINES ET CARROSSERIE

SERRES DE PORTE (voir aussi nos pages CABE I-H, FLAT AGRI, FORD, M-F, LANDINI)			
N° FIG	REFERENCES	CARACTERISTIQUES	
		COTE	APPLICATIONS
1	6065	droite	modèles courants (France, Belgique)
	6066	gauche	
2	6329	droite	types très courants sur cabines françaises
	6330	gauche	
3	13/1438LH	gauche	Case-IH, D.Brown; Peclain K.303805, K.303806; Deutz 04339352 & 04339353 (séries 07C et DX, salons équipement); Ford 3944243 & 3944244 (2310 → 7710 avec cabines, LP ou AP).
	13/1438RH	droite	
3	13/1441LH	gauche	Deutz 04386521 & 04386534 (DX4.61, DX4.71, DX6.11, DX6.31, DX6.61)
	13/1441RH	droite	
3	13/1421LH	gauche	M-F. 3477355M91 & 3477359M91 (Industrialis 20E, 25, 40E, 50E, 50EX)
	13/1421RH	droite	
4	13/1433LH	gauche	Deutz 04386520 & 04386533 (DX4.61, DX4.71, DX6.11, DX6.31, DX6.61)
	13/1433RH	droite	
5	13/1430	-	Ford Industrial 3902003, M-F. 1834022M91 (135, 165, 171, 173 (England))
	13/1431	-	
6	5.4003	gauche	Ford 3909273 & 3909274 (4830, 2600 → 9700, 2610 → 8210, TW.10 → TW.35); M-F. 3473297M91 & 3473298M91 (240, 250, 265, 275, 290, 20E, 30D)
	5.4002	droite	
7	D.3359		Cadre 30 x 20 mm
8	E.1015	droite	Pour cabines anglaises (85,7 x 69,8 mm)
	E.1016	gauche	
9	30/1670670	gauche	Massey-Ferguson
	30/1670670	droite	
10	L.1427/893	droite	Cabines Isabeanne SIAC
	L.1427/894	gauche	

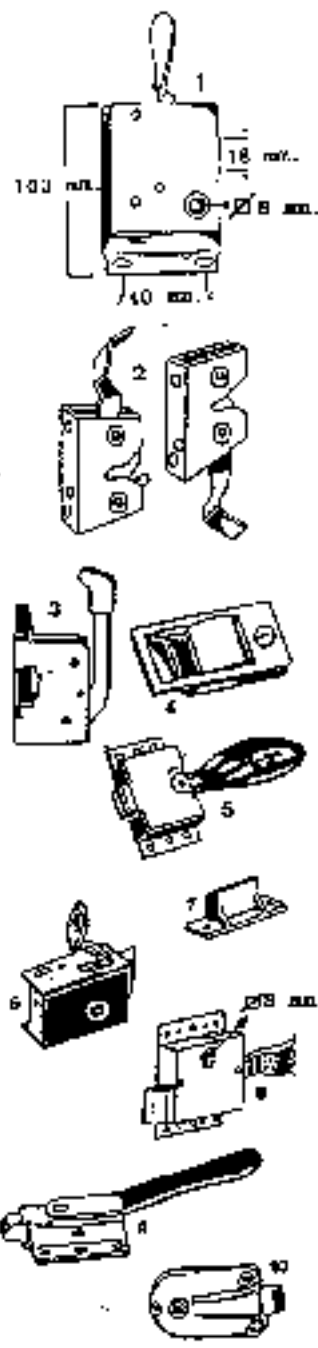

Continuation page suivante

"Un service sûr"

2/2000

**ACCESORIOS DE CABINA**

Accesorios (suite)

**ACCESORIOS ET RECHANGES POUR CABINES ET CARROSSERIE**

POIGNES DE PORTE		
N° FIG	REFERENCES	CARACTERISTIQUES
1	6734	Poignée chromée avec serrure et 2 clefs (M.F. 1877159M92)
	6734/SC	Poignée chromée sans serrure
2	6820	Poignée chromée extérieure avec serrure et 2 clefs (Ford 3944231/232)
	13/1447	David Brown K955435, Ford 3929344
3	6821	Poignée intérieure
4	13/1426	M.-F. 1897727M91 & 3473512M91 (240, 256, 265, 275, 280, 20B, 30D, cabine Saurer)
5	13/1445	D. Brown K. 773205 & K. 773206, LH et RH (885, 950, 990, 996, 1210, 1410, 1412)
	13/1414	Ford 1822794 (2000 → 2600 (1970/76)); M.-F. 1834003M91 (135, 163, 175, 178 (England))
6	13/1443	D. Brown K. 260004 (885, cabine LP 1100001 →); J. Deere AL25957/AR 91895 (séries 39, 40, 50)
	13/1429	Deutz 04345504 (séries 07C, D-4507C → 7207C); Ford 3944249 (série 10, (2310 → 7710), 2/84)
	13/1417	M.-F. 3476351M1 (série 300)
	13/1418	M.-F. 3477356M1 (Industrie 20P, 40E, 50E, 50EX)
	13/1415	M.-F. 1473396M91 (Industrie 30H, 50H, 50HX, 60HX)

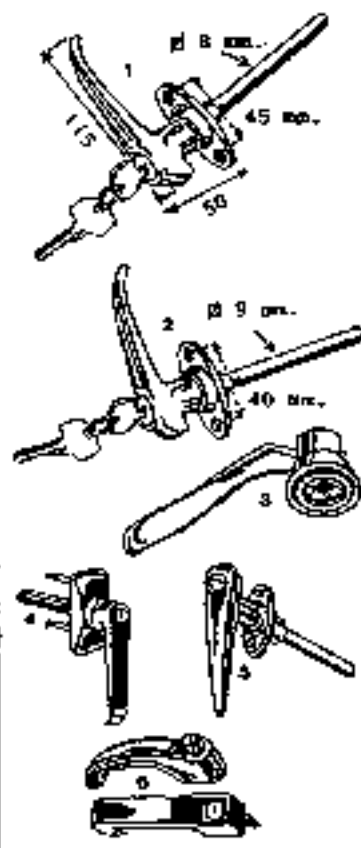

	Pneus (C) (gommages minif) (Pneumatic (small rubber))				Pneus (D) (gommages) (Pneumatic (Black))					
Ref. Ref.										
	70/4110-9	70/4110-10	70/4110-11	70/4111-4	70/4110-12	70/4110-13	70/4112-2	70/4112-3	70/4112-4	70/4112-5
Dim. glace / Glass size	6,0mm	4,7mm	4,7mm	Letel pour / Filles only	5,0mm	4,0mm	6,0mm	2,0 2,0mm	5,0mm	2,5mm
Épais / Thick	1,2-1,6mm	1,2-1,6mm	2,6-3,2mm	(sur A, B, C)	2,0mm	2,0mm				

**"Un service sûr"**

-14-

ECHAPPEMENT

POTS D'ECHAPPEMENT ADAPTABLES

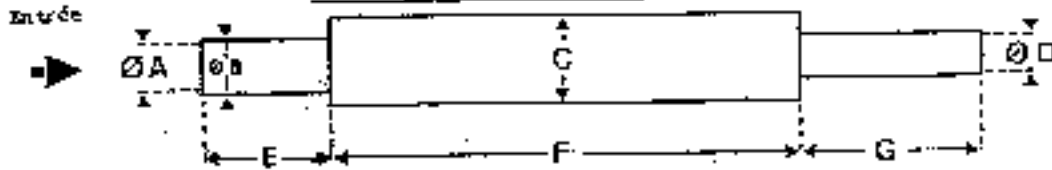

réf.	Ø A	Ø B	Ø C	Ø D	E	F	G
M.890476	39/41	42	82	39	80	620	190 mm.
P.57/5230	41/44	45	93	43	210	455	230 mm.
SR.587984	45/48	52	93	58	145	540	300 mm.
SR.1129	47/50	52	112	38	100	450	720 mm.
SR.1128	47/50	52	112	39	100	300	450 mm.
FD.5230	48/50	51	110	51	165	400	210 mm.
SR.014546	48/51	52	110	48	145	630	380 mm.
M.894291	51/53	54	85	44	50	680	490 mm.
K.010/2205	51/53	54	110	44	155	450	215 mm.
M.890670	54/57	58	100	42	60	590	455 mm.
M.1876423	54/57	58	110	55	115	480	460 mm.
27/150088	56/59	60	132	53	75	610	480 mm.
R.529372	60/62	63	128	61	70	340	300 mm.
X.010/1788	60/62	63	110	47	165	450	225 mm.
R.3245278	60/62	63	132	60	185	405	290 mm.
FD.5/52306	61/62	64	110	59	100	680	130 mm.

COLLIERS DE SERRAGE



réf. n°	Ø
MC.5853	43 mm.
MC.5855	45 mm.
MC.5853	40 mm.
MC.5854	50 mm.
MC.5856	54 mm.
MC.5854	58 mm.
MC.5861	60 mm.
MC.5865	65 mm.

Tous ces types de pots d'échappement peuvent être montés horizontalement ou verticalement. Déterminer le modèle désiré en se référant aux caractéristiques du tableau ci-dessus. Les longueurs E et G peuvent être raccourcies.

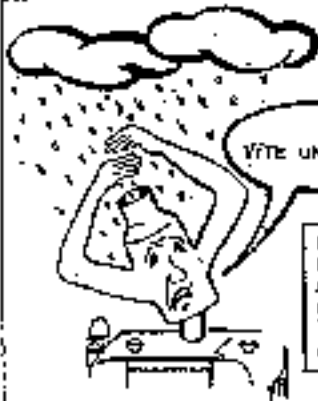

COUVERCLES PROTECTEURS

VITE UN RAINCAP

Adaptables au tuyau d'échappement. Se coule dès le niveau en marche du moteur. Protection efficace contre la pluie, l'humidité ambiante et autres agents destructeurs.

POUR UNE DEPENSE MINIMALE!

Halte aux dégâts causés aux moteurs par l'humidité ambiante qui pénètre par le tuyau d'échappement (un tuyau recourbé ne protège pas...). En outre, un "RAINCAP" ne laisse pas les gaz tirés dans le collecteur, ce qui favorise le démarrage à froid et soulage batterie et démarreur.

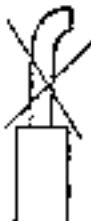

TYPES "A" SUPER RAINCAP

5870/01	Ø 32-35 mm.
5870/03	Ø 38-40 mm.
5870/10	Ø 43-50 mm.
5870/21	Ø 51-54 mm.
5870/22	Ø 57-63 mm.
5870/23	Ø 64-70 mm.
5870/24	Ø 70-76 mm.
5871/25	Ø 76-83 mm.
5871/26	Ø 86-92 mm.
5871/27	Ø 95-98 mm.
5871/28	Ø 100-108 mm.

50/360	Ø 109 mm.	types travaux publics
50/361	Ø 114 mm.	
50/362	Ø 127 mm.	
50/363	Ø 152 mm.	

TYPES "B" SANS COUVERCLES

5871	Ø 57 mm.
5872/70	Ø 70 mm.
5872	Ø 83 mm.

Produit simplifié



ARRÊTEUR D'ÉTINCELLES POUR ECHAPPEMENT.

★ HALTE AU FEU !



Protection contre l'incendie dans les bois, sciages, travaux de moisson... .

TPCM.06/037	Ø A 2" (50.80mm)
TPCM.06/5030	Ø A 2,5" (63.50mm)

Nevez déguiser votre responsabilité dans un sinistre causé dans lequel serait impliqué un engin équipé d'un arrêt d'étincelles.

# GARDE-BOUE POUR ROUES AVANTS

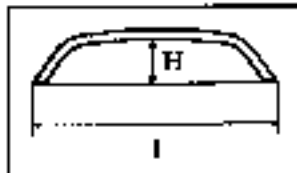
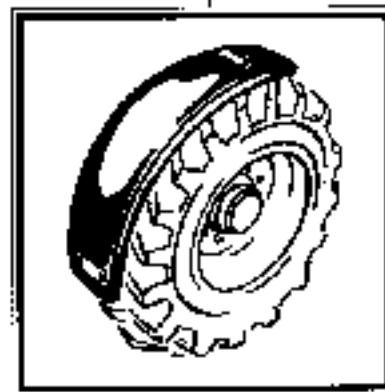
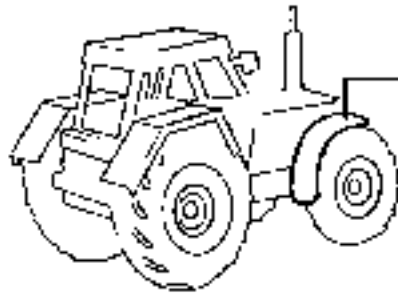

Dimensions of Tractor	L (mm)	L (mm)	R (mm)	H (mm)		
4.00-15, 5.00-15, 4.50-16, 5.00-16, 5.50-16, 6.00-16, 4.00-19, 4.50-19, 6.00-19	185	700	440	35	1	5070-2100
7.50-15, 6.50-16, 7.00-16, 7.50-16, 7.50-18, 6.00-20, 6.50-20, 7.5-24	225	810	530	32	1	5070-2300
6.50-20, 7.50-20, 8.00-20, 7.5-24	270	925	520	35	1	5070-2400
7.50-16, 7.50-18, 7.50-20, 9.00-16	260	910		25	2	5070-2500
9.5-20, 8.5-24, 9.5-24, 8.5-28, 9.5-28	265	1000	615	35	1	5070-2600
9.00-16, 10.00-16, 10.5-18, 10.5-20, 11.2-20, 275/80 R20, 11.2-24, 11.2-26, 12.5/80-18, 275/80 R18	310	1070	660	40	1	5070-2700
10.00-16, 10.5/80-15, 11.00-16	320	910		35	2	5070-2800
12.4-24, 11.2-22, 320/70 R28	330	1180	720	45	1	5070-2900
10.00-24, 11.00-24, 10.00-26, 11.00-28	350	1240		35	2	5070-3000
11.00-16, 12.5-18, 275/80 R18, 11.4-20, 12.5-20, 335/80 R20, 12.4-24, 320/70 R24, 360/70 R24	395	1085	660	40	1	5070-3100

1 : Thermoplastique  
2 : Plastique renforcé

70 : Pneu étroit  
80 : Pneu large

Tous références des pièces sont indicatives.  
Nos pièces ne sont pas d'origine.

Part numbers are quoted for reference purposes only.  
Our parts and accessories are not original.



**"THE RELIABLE SERVICE"**



(16.1) - 1/88

**GARDE-BOUE POUR ROUES AVANTS (Suite)**

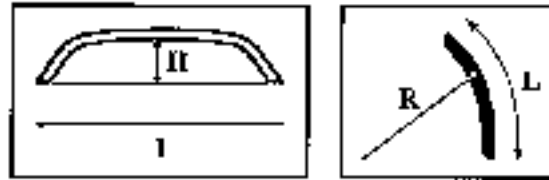

	L (mm)	L (mm)	R (mm)	H (mm)		
13.6-24, 12.4-28, 320/70 R28, 12.4-32	355	1245	720	35	1	
14.5-20, 375/75 R20, 405/70 R24, 13.6-24, 14.9-24, 360/70 R24, 380/70 R24, 14.9-26, 13.6-28, 360/70 R28	400	1315	720	40	1	
12.00-24, 13.00-24, 12.00-28, 13.00-28, 13.00-30	400	1320		30	2	
405/70 R20, 380/70 R24, 13.6-28, 14.9-28, 360/70 R28	410	1250	720	40	1	
425/75 R20, 16.9-24, 420/70 R24, 445/70 R24, 16.9-26, 480/70 R26, 420/70 R28, 480/70 R28, 420/70 R30	470	1300	780	45	1	
425/75 R20, 16.9-24, 420/70 R20, 16.9-26, 14.9-28, 11.2-32	470	1400	780	45	1	
14.00-24, 14.00-28, 14.00-30, 18.4/70 R28, 18.4/30	470	1440		40	2	
18.4-26, 14.9-28, 16.9-30, 18.4-30, 480/70 R30, 16.9-34	480	1120	815	50	1	
19.5-24, 19.5-28, 18.4-26, 430/70 R26, 480/70 R28, 480/70 R30, 18.4-30, 18.4-34	520	1550	820	50	1	

1 : Thermoplastique  
2 : Plastique renforcé

/70 : Pneu étroit  
/80 : Pneu large

Les références des pièces sont indicatives.  
Nos pièces ne sont pas d'origine.

Part numbers are given for reference purposes only.  
Our parts are not necessarily original.



**"THE RELIABLE SERVICE"**



(14.83) 11.06

**BEPCO PARTS SA****HERMALLE-SOUS-HUY**

Rue Chaumont, 4D • 4480 Hermalle-sous-Huy • Belgique  
T +32 85 24 54 00 • F +32 85 24 54 50  
info.be@becoparts.com • www.becoparts.com

**VILLERS-LE-BOUILLET**

Rue de Waremme, 114 • 4530 Villers-le-Bouillet • Belgique  
T +32 85 24 54 00 • F +32 85 24 54 50  
info.be@becoparts.com • www.becoparts.com

**BEPCO UK LTD**

Bepco House • Unit 316 • Hartlebury Trading Estate  
Hartlebury - Worcestershire, DY10 4JB (UK)  
P +44 (0)1299 252270 • F 0800 216553  
info@becoparts.com • www.becoparts.com

**BEPCO FRANCE SAS**

Z.I. La Plaine, Allée de Bigorre  
BP80041 Le Passage • 47901 Agen Cedex 9 • France  
T +33 (0)553 96 31 25 • F +33 (0)553 68 03 72  
info.fr@becoparts.com • www.becoparts.com

**VILLENEUVE-SUR-LOT**

294 Av. de Bordeaux • CS 30059 Bias  
FR-47302 Villeneuve sur lot • France  
T +33 (0)5 53 40 37 50 • F +33 (0)5 53 70 61 93

**JANZÉ**

P.A. de la Chauvelière • Rue Charles Lindbergh  
35150 JANZE • France  
T + 33 (0)2 99 44 16 18 • F +33 (0)2 99 44 17 29

**TVH AUSTRALASIA PTY LTD**

HEAD OFFICE BRISBANE • www.becoparts.com

**ADELAIDE**

96 South Terrace • Wingfield SA 5013  
Free 1800 182 344 • T +61 8 8359 8933 • F +61 8 8234 2212  
BepcoSAsales@tvh.com.au

**BRISBANE**

735 Boundary Road • Richlands QLD 4077  
Free 1800 020 082 • T +61 7 3344 1113 • F +61 7 3344 1332  
BepcoQLDsales@tvh.com.au

**MELBOURNE**

7/66-74 Micro Circuit • Dandenong South VIC 3175  
Free 1800 802 367 • T +61 3 9796 5422 • F +61 3 9796 5251  
BepcoVICsales@tvh.com.au

**PERTH**

2/15 Colin Jamieson Drive • Welshpool WA 6106  
Free 1800 182 344 • T +61 8 8352 8984 • F +61 8 8234 2212  
BepcoWAsales@tvh.com.au

**SYDNEY**

1/1002-1010 Canley Vale Rd • Wetherill Park NSW 2164  
Free 1800 808 827 • T +61 2 6885 5288 • F +61 3 9796 5251  
BepcoNSWsales@tvh.com.au

**TVH NEW ZEALAND LTD****AUCKLAND**

PO Box 51490 • Pakuranga 2140 • 11K Echelon Place  
East Tamaki • Auckland  
Free 0800 459 662 • T +64 9 274 9695 • F +64 9 274 9698  
info@tvh.co.nz • www.tvh.com

**CHRISTCHURCH**

11C Parkhouse Road  
Wigram • Christchurch 8042  
Free 0508 8 722 867 • T +64 3 550 1298 • F +64 3 974 9993  
infochch@tvh.co.nz

**BEPCO DEUTSCHLAND GmbH**

Neuer Weg 5 • 59505 Bad Sassendorf • Germany  
T +49 (0)2927 919 59 0 • F +49 (0)2927 919 59 59  
info.de@becoparts.com • www.becoparts.com

**BEPCO NEDERLAND BV**

Den Dolvert 10 • 5473 GP, Heeswijk-Dinther • Nederland  
T +31 (0)413 29 39 75 • F +31 (0)413 29 40 87  
info.nl@becoparts.com • www.becoparts.com

**BEPCO IBÉRICA SA**

C/ Torrent de Vallmajor, 82  
08915 Badalona (Barcelona) • Spain  
T +34 (0)902 111 062 - 933 810 062 • F +34 (0)933 813 345  
info.es@becoparts.com • www.becoparts.com

**ALMENDRALEJO**

Ctra. Badajoz - Pol. «Rayvaz» Nave 21  
06200 Almendralejo (Badajoz)  
T +34 (0)902 111 062 - 924 664 890  
F +34 (0)924 664 576

**DOS HERMANAS**

Pol. Ind. La Isla, C/ Hornos, 11  
41703 Dos Hermanas (Sevilla)  
T +34 (0)902 111 062 - 954 931 546  
F +34 (0)954 930 130

**SANTIAGO DE COMPOSTELA**

Pol. El Tambre, Via Faraday, 36  
15890 Santiago de Compostela  
T +34 (0)902 111 062 - 981 560 012  
F +34 (0)981 557 753

**TVH PARTS SOUTH AFRICA (Pty) Ltd**

HEAD OFFICE JOHANNESBURG • www.tvh.com

**CAPE TOWN**

1 Karee Street • Kraaifontein Industries • Cape Town 7571  
T +27 21 988 2432 • F +27 21 988 9127  
capetownsales@tvh.com

**DURBAN**

2 Monaco Place • Westmead • Pinetown 3600  
T +27 31 100 0760 • F +27 31 700 6191  
durbansales@tvh.com

**JOHANNESBURG**

90 Electron Avenue • Isando • Kempton Park 1601  
T +27 11 281 27 00 • F +011 974 9845  
johannesburgsales@tvh.com

**LICHTENBURG**

Shop 1 • 109 Scholtz Street • Lichtenburg 2740  
T +27 18 632 6192/6092 • F +27 18 632 6108  
lichtenburgsales@tvh.com

**PORT ELIZABETH**

134 Kempston Road • Korsten • Port Elizabeth 6020  
T +27 41 453 1404/8 • F +27 41 453 1409  
portelizabethsales@tvh.com



## FOR ALL OUR LATEST CATALOGUE UPDATES AND COMPANY INFO: [WWW.BEPCOPARTS.COM](http://WWW.BEPCOPARTS.COM)



The spare parts mentioned in this list can normally be delivered from stock. In addition, we can supply parts, which are not mentioned in this catalogue, with the shortest possible delivery time. The O.E.M. references are only for indication purposes and do not imply that the spare parts are coming from the manufacturer. This spare parts list can be modified without prior notice. All photographs, drawings, illustrations, brand names, descriptions and numbers are included for identification purposes only.



De onderdelen vermeld in deze lijst, zijn normaal uit voorraad leverbaar, behoudens uitverkocht. Ook niet-vermelde onderdelen kunnen binnen de kortste tijd uitgeleverd worden. De O.E.M. referenties dienen enkel ter indicatie en impliceren niet dat deze van de vermelde constructeur afkomstig zijn. Deze onderdelenlijst kan zonder enige voorafgaande verwittiging aangepast worden. Alle gebruikte foto's, tekeningen, afbeeldingen, merknamen, omschrijvingen en nummers dienen alleen ter identificatie.



Les pièces de rechange, mentionnées dans cette liste, sont normalement livrables du stock. En plus, les articles non indiqués peuvent être fournis en peu de temps. Cette liste peut être modifiée sans avis préalable. Les références O.E.M. sont seulement indicatives et n'impliquent pas que les pièces de rechange viennent du constructeur. Toutes les photographies, illustrations, marques, descriptions, tous les plans et numéros servent exclusivement à une identification.



Die in dieser Liste aufgeführten Teile sind normalerweise aus dem Lager lieferbar. Wir sind zudem in der Lage nicht aufgeführte Teile innerhalb kürzester Zeit zu liefern. Die O.E.M. Referenznummern dienen zur Information und beinhalten nicht, dass diese vom genannten Hersteller kommen. Diese Bestandsliste kann ohne vorhergehende Ankündigung geändert werden. Alle verwendeten Foto's, Zeichnungen, Abbildungen, Markennamen, Beschreibungen und Nummern dienen nur zu Identifikationszwecken.



Los artículos mencionados en este catálogo se encuentran habitualmente en stock. Además, podemos suministrar en un plazo corto de tiempo otros artículos relacionados que no se encuentren expresamente mencionados en este catálogo. Las referencias O.E.M. sirven sólo como indicación y no implican que procedan del constructor. Este listado de productos puede estar sujeto a modificaciones sin aviso previo. Todas las fotos, dibujos, ilustraciones, nombres de marca, descripciones y números se han incluido simplemente con el propósito de su identificación.



I pezzi di ricambio, menzionati in questo listino, possono essere forniti con una consegna immediata a condizione che non siano esauriti. I pezzi di ricambio non menzionati possono essere forniti in poco tempo. Le referenze O.E.M. sono solamente indicative e non implicano che i pezzi di ricambio vengano da questo costruttore. Questa lista ricambi può essere aggiustata senza avvisi anticipati. Tutti i numeri, codici, nomi, foto, spaccati e disegni sono solo a titolo informativo.



Części z tego katalogu są zazwyczaj na stanie magazynowym. Również części które nie są wyszczególnione w katalogu mogą być dostarczone na zamówienie w najkrótszym możliwym terminie. Opis części O.E.M. jest używany informacyjnie i nie wskazuje na to, że dany produkt jest wyprodukowany przez podanego producenta. Zawartość katalogu może ulec zmianie bez wcześniejszego informowania o tym. Wszystkie użyte zdjęcia, rysunki, nazwy marek, opis i numery służą tylko do identyfikacji.



Запчасти из настоящего списка, как правило, имеются в запасе, если только он не распродан. Прочие, не фигурирующие в списке артикулы, могут быть поставлены в самые кратчайшие сроки. Указание оригинальных номеров производителя не предполагает обязательного оригинального происхождения самих деталей. Данный список может изменяться без предварительного уведомления. Все использованные фото, рисунки, иллюстрации, названия брендов, наименования и номера служат исключительно для цели идентификации.

Visita nuestro sitio Web :  
**[www.bepcoparts.com](http://www.bepcoparts.com)**

© **bepco** 2015

Todos los derechos reservados. Ninguna parte de este catálogo puede ser reproducida o comunicada en cualquier forma o por cualquier medio, electrónico o mecánico, incluyendo la copia, la grabación o el uso en un sistema de almacenamiento o recuperación de información, sin el permiso previo y explícito de BEPCO.

- BEPCO es un proveedor de piezas de recambio y accesorios adecuados para el mantenimiento y reparación de equipos originales. Las referencias y marcas originales son puramente indicativas y no implican que los accesorios y / o piezas de recambio sean las del fabricante original.
- Los productos que no cumplan con los requisitos reglamentarios de la marca CE no se comercializan en el Espacio Económico Europeo.
- BEPCO® es una marca registrada.
- Todas las ventas están sujetas a los términos y condiciones generales de venta en [www.bepcoparts.com](http://www.bepcoparts.com)
- Se incluyen fotografías e ilustraciones sólo a título indicativo. Sin responsabilidad por errores de impresión.



**Recambios**  
**para todas**  
**las marcas**  
*de la A a la Z*

Case IH  
David Brown  
Fendt  
Ford  
Fiat  
Hürlimann  
JCB  
John Deere  
K.H.D. (Deutz)  
Kubota  
Landini  
Lamborghini  
Manitou  
Massey Ferguson  
Mc Cormick  
Merlo  
New Holland  
Renault  
Same  
Steyr  
Valmet  
Zetor

*moving forward in every field*

REF. B71148



**HEAD OFFICE**

Rue Chaumont 4D • 4480 Hermalle-sous-Huy • Belgium  
T +32 (0)85 24 54 00 • F +32 (0)800 23 132 • info.be@bepcoparts.com • www.bepcoparts.com

Member of **TVH** 