



moving forward in every field

IDIOMA • EN/ES

MOTORES DE ARRANQUE

▶▶ ACCESORIOS

Catálogo - Primera edición: 1994

www.bepcoparts.com

Member of **TVH** 

PRESENTACIÓN DE BEPCO

El Grupo BEPCO es líder mundial en el suministro de recambios y accesorios para tractores y máquinas agrícolas.

Con más de 360 empleados, el Grupo BEPCO tiene delegaciones en Bélgica, Holanda, Francia, Alemania, España y el Reino Unido. También está presente en Australia, Nueva Zelanda, Sudáfrica y Brasil.

El Grupo BEPCO es una compañía global con clientes en más de 100 países y con ventas fuera de Europa que contribuyen a más de una tercera parte de su facturación.

Ofrecemos a nuestra red de distribuidores y concesionarios :





- ▶▶ Marcas de proveedores de piezas originales y otras marcas líderes
- ▶▶ Más de 20.000 m² de almacenes
- ▶▶ Más de 80.000 artículos disponibles
- ▶▶ Personal experto en conocimientos técnicos
- ▶▶ Envíos el mismo día del pedido, con entregas al día siguiente en muchos mercados

El Grupo BEPCO es miembro de TVH, el mayor suministrador de piezas y accesorios de alta calidad para máquinas de manipulación, vehículos industriales y otros equipos agrícolas.

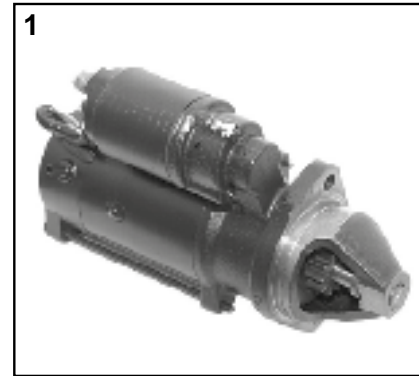
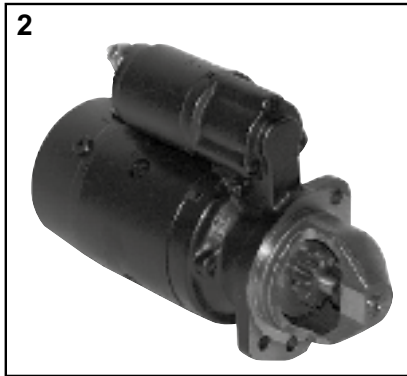
K.H.D DEUTZ-FAHR PARTS

Démarrreur - Starter motor - Anlasser - Startmotor - Motor de arranque



|  | Fig. | Part N° | OEM |  |  |  |  |
|---|------|-------------------|----------------------|---|---|---|---|
| F2L1011,F3L1011, F4L1011,BF4L1011 (01-95⇒) | 2 | 62/930-185 | 01180180 01180995 | 11Z | 2x11mm (A) x 105 mm (B) | 220mm | 2.8 KW 12V |
| F2L1011,F3L1011, F4L1011,BF4L1011 (06-89⇒12-94) | 1 | 62/930-205 | 01177441 01178670 | 11Z | 3x11mm (A) x 105 mm (B) | 220mm | 2.7 KW 12V |





Les références des pièces sont indicatives.
Nos pièces ne sont pas d'origine.

Part numbers are quoted for reference purposes only.
Our parts and accessories are not original.



REPLACEMENT PARTS FOR STEYR

Démarrreur - Starter motor - Anlasser Starter - Motor de arranque

| Tracteurs Tractors | Moteur Engine | OEM | Réf. Ref. |  A x B | Z  |  L |
|--|------------------|-----|---------------------|---|--|---|
| 30, 86, 188, 190, 430, 540, 545, 548, 650, 658, 760, 768, 780, 870 | | | 62/930-195 Iskra | 2 x 105 x 13.5  12 V | 9 z 2.7 kW | 247mm |

Les références de pièces sont indicatives.
Nos pièces ne sont pas d'origines

Parts numbers are quoted for reference purposes only.
Our parts and accessories are not original









"THE RELIABLE SERVICE"



STEYR PARTS

Démarrreur - Starter motor - Anlasser - Startmotor - Motor de arranque

|  | Part N° | OEM |  |  |  |  |
|---|-----------------------------------|--|--|---|---|---|
| 8055, 8055A, 8060, 8060A, 8060TA, 8065A | 62/930-194 Iskra | 131100090017 141100090015 141100090902 | 12 V / 2.7 kW | 2x105 | 9Z | 245mm |
| | | | |  | | |

Les références des pièces sont indicatives.
Nos pièces ne sont pas d'origine.

*Part numbers are quoted for reference purposes only.
Our parts and accessories are not original.*



"THE RELIABLE SERVICE"



ELECTRICALS

**DEMARREURS
STARTERS
ANLASSER
STARTMOTOREN
MOTORES DE ARRANQUE**



LUCAS Licensed
Designed

| | | Ref. | Lucas | OEM |
|----------------------------|--|------------------------------------|---------|--|
| Massey Ferguson | Std.gazoline engines (TE.20, FE.35) | 62/930-1L | LRS 101 | 25198, 25038 |
| Massey Ferguson | TE.F 20C (Diesel), 35 (23C Diesel) | 62/930-3L | LRS 157 | 26133 |
| David Brown | 850, 950, 990, 995, 996, 1200, 1210, 1212, 1290, 1294, 1390, 1394, 1410, 1412, 1490, 1494 (80-83) | | | K954700, K89772, K957340 |
| Massey Ferguson | 35 (A3.152), 65, 133, 135, 140, 145, 148, 152, 154F, 165 (AD4.203), 194F, 230, 234C, 235, 240, 245, 250, 254, 254C, 255, 350, 355, 360, 550, 765, 5500,6000 | 62/930-4L Normal Duty | LRS 190 | 1680065M3, 2873A012, 2873A104 |
| Massey Ferguson Industrial | 20, 20B, 20D, 20E, 30E, 40, 50 (AD4.203) | | | 714/14200R |
| JCB | 2CX Backhoe-Loader 1992>> 406 Loader | | | |
| Massey Ferguson | 148, 165(A4.212), 168, 175, 178, 185, 188, 194F, 265, 275, 290, 565, 575, 590, 6500, 8500 | 62/930-5L | LRS 215 | 1680064M1 |
| Massey Ferguson Industrial | 30, 50(A4.212) | | | |
| Case IH | 275, 276, 354, 384, 414, 434, 444 | 62/930-7L | LRS 172 | 3046890R93, 3114177R91 |
| Ford | 2000, 2600, 2610, 2910, 3000, 3310, 3600, 3610, 3910, 4000, 4100, 4110, 4600, 4610, 5000, 5600, 5610, 5700, 6600, 6610, 6700, 6710, 7000, 7600, 7610, 7610, 7700, 7710, 7910, 8210, 8600, 8700, 9600, 9700, TW-5, TW-10, TW-15, TW-20, TW-25, TW-30, TW-35 | 62/930-9L | LRS 212 | D8NN11000CA, 83912206, 83918688, D2NN11000B, 83981923, D7NN11000B, D4NN11000B, D8NN11000CA, 83901270, 81833782 |
| Massey Ferguson | 133, 135, 140, 145, 148, 152, 155, 158, 165(AD4.203), 230, 235, 240, 245, 250, 255, 350, 355, 360, 550, 560 | 62/930-10L Heavy Duty | LRS 301 | 1868283M5, 3597371M1, 3597372M1, 1860093M2, 1680065M3 |
| Massey Ferguson Industrial | 20, 20B, 20D, 20E, 30E, 40 | | | |

Les références des pièces sont indicatives.
Nos pièces ne sont pas d'origine.

Part numbers are quoted for reference purposes only.
Our parts and accessories are not original.



"THE RELIABLE SERVICE"



ELECTRICALS

**DEMARREURS
STARTERS
ANLASSER
STARTMOTOREN
MOTORES DE ARRANQUE**



LUCAS Licensed
Designed

| | | Ref. | Lucas | OEM |
|----------------------------|---|-------------|--------------------|--|
| Massey Ferguson | 165 (A4.212), 168, 175, 178, 185, 188, 265, 275, 290, 365, 375, 390, 398, 399, 565, 575, 592, 595, 620, 675, 690, 698, 698T, 699, 1014, 1080, 1134, 3050, 3060, 3065, 3070 | 62/930-11L | LRS 232 | 1868285M3, 3597372M1, 1860093M2 |
| Massey Ferguson Industrial | 30, 30D, 50, 50B, 50BMkII, 50D, 50E, 50H, 50HX, 60H | | | |
| Case IH | 454, 474, 484, 485, 574, 584, 585, 674, 684, 685, 784, 785, 884, 885 | 62/930-13L | LRS 240 | 537140R92 |
| Massey Ferguson | 174, 184, 194F, 285S, 298, 365, 375, 390, 398, 399, 698, 698T, 699, 1200, 1250 | 62/930-14L | LRS 306 LRS 969 | 2873B055, 3530590M91, 2873002, 2873006, 2873B072 |
| JCB | 2CX, 2DX, 3C, 3CX, 3D, 407, 408, 409, 410, 411, 412, 412S, 415, 416, 420, 430, 520-50, 520-55, 520M, 525-58, 525B, 526, 530, 530B, 540B, 805BT, 806C, 811, 812, 814, 926, 930 | | | |
| Massey Ferguson | 2620, 2640, 2680, 2625, 2645, 2685, 2720, 2725, 3080, 3090, 3610, 3630, 3650 | 62/930-16L | LRS 553 | 1618050M4 |
| Fiat | 446, 446DT, 466, 466DT, 480, 480DT, 480V, 500, 500DT, 500DTS, 500S, 540, 540DT, 540DTS, 540F, 540FS, 540S, 540VS, 566, 566DT, 570, 580, 45-66, 50-66, 55-46, 55-56, 55-66, 55-89, 60-46, 60-56, 60-66, 60-90, 60-93, 60-94, L60 | 62/930-77L | LRS 850 | 4710224, 4728682, 4807373, 4739353, 4628998, 4722682 |
| Massey Ferguson | 3085, 3095, 3115, 3120, 3125, 3635, 3645, 3655, 3670, 3680, 3690, 6160, 6170, 6180, 6190, 8110, 8120, 8130, 8140, 8150, 8160 | 62/930-104L | LRS 968 | 3581576M1, 2873B056, 2873B071 |
| JCB | 3CX, 4CX, 420, 430, 807C, 811, 812, 814, 817, 818, 820, Fastrac (635) 125, 145, Fastrac (636) 125, 135, 155, 185, Fastrac (736) 1115, 1135 | | | |

Les références des pièces sont indicatives.
Nos pièces ne sont pas d'origine.

Part numbers are quoted for reference purposes only.
Our parts and accessories are not original.











DEMARREURS

| DEMARREURS / STARTING MOTORS / STARJMOTOREN - LICENCE "MAGNETI MARELLI" | | | | | | | | | | |
|---|-----------|-----------|----------|----------|----------|---------------|----------|------------------------|----------|--------------------------|
| | INDUCTEUR | INDUCTION | CONCRETE | PALLER | BOUCS | POSTE-CONTACT | ENGAGE | MINI-CAU | RESERVE | TRACAT |
| CASE - LIL (David Denon et Internationall) | | | | | | | | | | |
| 40-37/2627B | 72165001 | 72163701 | 72316115 | 72030352 | 72362510 | - | 72362210 | 63633825 (63633825) | 72164101 | (R) 72163203 72363704 |
| 5220147 | 72304116 | 72366801 | 72357102 | 72357282 | - | - | - | 63600301 | 72363110 | 72363704 |
| IS/0220B T-R | 72366112 | 72013501 | 72166701 | 72390349 | 72362510 | 72366601 | 72362910 | 63600302S | 72260110 | 72363203 |
| licenciacione arrêché | 72394114 | 72313941 | 72166701 | 72030309 | 72362510 | 72366601 | 72362910 | 63633825 (63633825) | 72164101 | 72363203 |
| 15/00506 L L | 72366103 | 72370301 | 72138801 | 72030306 | 72362510 | 72366601 | 72362910 | 63633825 (63633825) | 72364110 | 72363203 |
| 63295812R | 72165002 | 72313941 | 72166702 | 72030305 | - | - | - | 63633825 | 72164101 | 72363704 |
| 53295842 L L | | | | | | | | | | |
| R-3055414 | | | | | | | | | | |
| 61766801 | | | | | | | | | | |
| SC. 0585/01 L L | | | | | | | | | | |
| TERGOLSON (Mot. Standard / Motobiss II cyl.) voir LUFK-26278 (CASE - LH) | | | | | | | | | | |
| FENDT voir M.W.M. | | | | | | | | | | |
| PIAT - AGRI | | | | | | | | | | |
| 55-9007373 | 72166001 | 72162501 | 72150001 | 72030346 | 72362510 | - | 72362910 | 63633825 (63633825) | 72164101 | (A) 72163203 |
| 6321126 | 72366101 | 72300001 | 72150001 | 72030325 | 72362510 | 72166601 | 72362910 | 63633825 (63633825) | 72163110 | 72163203 |
| SP-4037755 (1ère série) | 72165001 | 72362501 | 72158801 | 72390346 | 72462510 | 72164701 | - | 63633825 | 72164010 | 72163203 |
| 5220147 (MARELLI) | 72366101 | 72362501 | 72158801 | 72390346 | 72462510 | 72164701 | - | 63633825 | 72164010 | 72163203 |
| SP-4037755 (2ème série) | 72165001 | 72362501 | 72158801 | 72390346 | 72462510 | 72164701 | - | 63633825 | 72164010 | 72163203 |
| 6321126 (MARELLI) | 72366101 | 72362501 | 72158801 | 72390346 | 72462510 | 72164701 | - | 63633825 | 72164010 | 72163203 |
| PA-4737758 | 72165001 | 72362501 | 72158801 | 72390346 | 72462510 | 72164701 | - | 63633825 | 72164010 | 72163203 |
| 6321126 | 72366101 | 72362501 | 72158801 | 72390346 | 72462510 | 72164701 | - | 63633825 | 72164010 | 72163203 |
| PA-4737759 | 72165001 | 72362501 | 72158801 | 72390346 | 72462510 | 72164701 | - | 63633825 | 72164010 | 72163203 |
| 6321126 | 72366101 | 72362501 | 72158801 | 72390346 | 72462510 | 72164701 | - | 63633825 | 72164010 | 72163203 |
| TORID | | | | | | | | | | |
| FD-37/1000AS | 72366101 | 72313516 | 72313515 | 72030330 | 72462510 | 72366601 | 72362910 | 63633825 (63633825) | 72363110 | 72363704 |
| 63295812 | 72464111 | 72313941 | 72313515 | 72030330 | 72462510 | 72366601 | 72362910 | 63633825 (63633825) | 72363110 | 72363704 |
| 63296029 L L | 72394107 | 72313641 | 72313515 | 72030330 | 72462510 | 72366601 | 72362910 | 63633825 (63633825) | 72363110 | 72363704 |
| PNN-110DU | 72366101 | 72313516 | 72313515 | 72030330 | 72462510 | 72366601 | 72362910 | 63633825 (63633825) | 72363110 | 72363704 |
| 63297105 | 72366101 | 72313516 | 72313515 | 72030330 | 72462510 | 72366601 | 72362910 | 63633825 (63633825) | 72363110 | 72363704 |
| 63297145 L L | 72366101 | 72313516 | 72313515 | 72030330 | 72462510 | 72366601 | 72362910 | 63633825 (63633825) | 72363110 | 72363704 |

"Un service sûr"

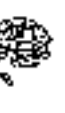
- 56 -

DEMARREURS

| DEMARREURS / STARTING MOTORS / STARIMOTOREN - LICENCE "MAGNETI MARELLI" | | | | | | | | | | |
|---|---|---|---|---|---|--|---|---|---|---|
|  |  |  |  |  |  |  |  |  |  |  |
| INDICACION | INDICACION | INDICACION | LAVICHER | FALTEZ | ENGDE | SPORT/TRACTA | BAGDE | REGAL | HESBERG | BALAST |
| JOHN DEERE | | | | | | | | | | |
| 15/06B04 J-D 63206004 | 72144162 | 72314032 | 72313612 | 72032307 | 72362510 | 72366601 | 72362910 | 63633625 (63693801) | 72164118 72164101 | 72363203 72363204 |
| ST-05066/01 (1) | 72165802 | 72314501 | 72313612 | 72032307 | | | | 63533825 | | |
| M.W.M. (FENDT, RENAULT) | | | | | | | | | | |
| 103-519797 (PERNADIT) 82-362306 (PUNET) 63256043 | 72165901 | 72313941 | 72336113 | 72030353 | 72362510 | 72164701 | 72362910 | 63603802 | 72164810 | 72162403 72162404 |
| PERKINS | | | | | | | | | | |
| TD-3/26264 6320680 | 72304103 | 72314031 | 72313615 | 72030321 | 72362510 | 72366601 | 72362910 | 63633625 (63693801) | 72164113 72164701 | 72363203 72363204 |
| SC-35062/01 (1) TD-5/26271 63256805 | 72165801 | 72313941 | 72313615 | 72030321 | | | | 63633625 | | |
| 63256805 | 72304111 | 72313561 | 72313615 | 72030322 | 72362510 | 72366601 | 72362910 | 63633825 | 72363110 | 72363203 72363204 |
| 63256835 (1) | 72304112 | 72313941 | 72313615 | 72030340 | | | | 63693801 | 72164701 | |
| SAME / LAMBORGHINI / EURLIMANN / STEYR | | | | | | | | | | |
| S-9639/060 (MARELLI) 63207108 | 72344108 | 72313461 | 72313611 | 72030306 | 72362510 | 72366601 | 72362910 | 63633825 (63693801) | 72364110 | 72363203 72363204 |
| S-9619/110 63206806 | 72344162 | 72314031 | 72165701 | 72030345 | 72362510 | 72366601 | 72362910 | 63633625 (63693801) | 72362110 | 72363203 72363204 |
| 33216894 (1) | 72165802 | 72162601 | 72165701 | 72030345 | | | | | 72164701 | |
| S-9619/180W 63206838 | 72344102 | 72314031 | 72130001 | 72030345 | 72362510 | 72366601 | 72362910 | 63633825 | 72362110 | 72363203 72363204 |
| | 72165802 | 72152601 | 72138801 | 72030345 | | | | | 72164701 | |

(1) Demarreur rationalisé (1991), certification Lest-e (1) corás marqués de la date. (Exemp: Te 06/916)

"Un service sûr"

-57-

DEMARREURS

PIECES DETACHEES - DEMARREURS "ISKRA"

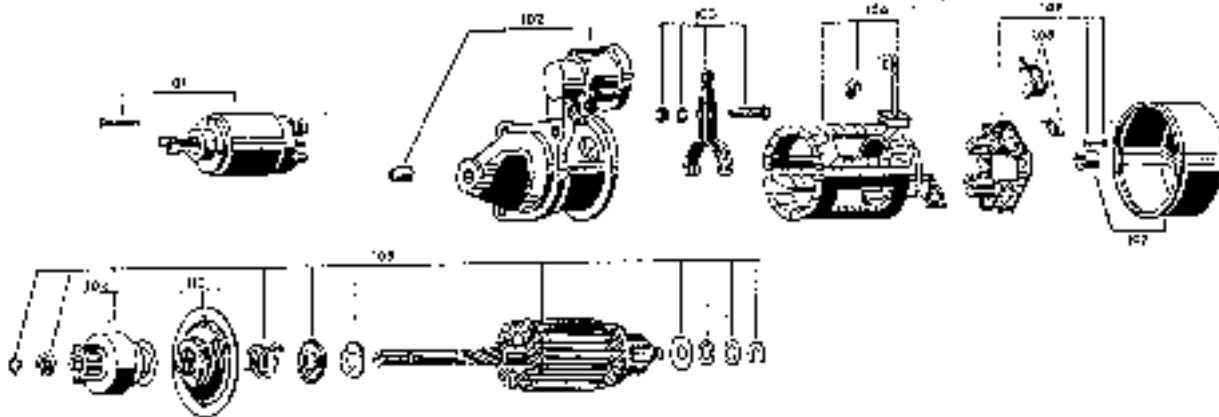

| DEMARREUR N° | TYPE | 101 RELAJ | 102 PALIER LEV. | 103 LEVIER | 104 PLANCHEUR | 105 INDUCT + ACC. |
|---------------|------------|--------------|--------------------|---------------|------------------|----------------------|
| 15/70436 | AZJ.3158 | 16.905.754 | 16.261.528 | 16.905.853 | 16.903.156 | 16.350.402 |
| K.073 (a) | AZJ.3102 | 16.905.143 | 16.261.005 | 16.905.144 | 16.900.117 | 16.305.116 |
| 07B.127 | AZJ.3534 | 16.905.240 | 16.261.134 | " | 16.900.212 | 16.305.239 |
| S.9619/080 | AZJ.3503 | 16.905.244 | 16.261.085 | " | 16.900.114 | 16.305.248 |
| SF.8962 407 | AZK.0102 | 16.500.054 | 16.261.014 | " | (a) | 16.360.828 |
| SLT.2040 | AZJ.3551 | 16.905.143 | 16.261.296 | " | 16.900.254 | 16.305.625 |
| ZR.6918 (b) | AZJ.3599 | " | 16.261.057 | " | 16.901.473 | 16.305.340 |
| ZR.976116 (c) | AZK.5112/M | 16.500.054 | 16.261.026 | " | 16.900.205 | 16.360.829 |
| VEM.500 | AZK.5112 | " | " | " | (a) | " |
| XF.117 | AZJ.3508 | 16.905.244 | 16.261.427 | 16.905.144 | 16.900.254 | 16.305.625 |

| DEMARREUR N° | TYPE | 106 INDUCTORS | 107 PALIER LEV. | 108 JEU BALAIS | 109 PORTES-BALAIS | 110 PALIER INT. |
|---------------|------------|------------------|--------------------|-------------------|----------------------|--------------------|
| 15/70436 | AZJ.3158 | 16.305.914 | 16.905.113 | " | 16.900.387 | 16.261.471 |
| K.073 (a) | AZJ.0402 | 16.305.225 | 16.905.481 | 16.905.226 | 16.900.147 | 16.261.059 |
| 07B.127 | AZJ.3534 | 16.305.226 | 16.905.451 | 16.905.226 | 16.900.147 | 16.261.059 |
| S.9619/080 | AZJ.3403 | 16.905.245 | " | 16.905.247 | 16.305.246 | " |
| SF.8962 407 | AZK.0102 | 16.500.803 | 16.261.205 | 16.900.387 | 16.300.482 | " |
| SLT.2040 | AZJ.3551 | 16.905.622 | 16.305.487 | 16.905.247 | 16.305.245 | 16.261.239 |
| ZR.6918 (b) | AZJ.3599 | 16.905.596 | " | 16.905.622 | 16.905.637 | 16.261.314 |
| ZR.976116 (c) | AZK.5112/M | 16.500.803 | 16.261.352 | 16.905.387 | 16.900.482 | " |
| VEM.500 | AZK.5112 | " | " | " | " | " |
| XF.117 | AZJ.3508 | 16.305.390 | 16.305.451 | 16.900.645 | 16.900.644 | 16.261.290 |

(a) et aussi F.073. SLT.073
(b) et aussi VEM.375













(c) et aussi VEM.521
(d) 16.900.337 + 16.100.096

"Un service sûr"

11/34

STARTER MOTORS
MOTORES DE ARRANQUE
CASE-IH
 DAVID BROWN















CASE-IH
 EUROPE

|  | Ref. Ref. | OEM OEM |  |  A x B Z |  L |
|--|---|--|--|---|---|
| CASE-IH DAVID BROWN | | | | | |
| 770, 780, 880, 885, 990 Selectamatic, 1190, 1194 | 62/930-6 | K913007 K957341 | 12 V / 2,8 kW | 3x146  | 11Z 230 |
| 850, 950, 990 Implematic, 995, 996, 1200, 1210, 1212, 1290, 1294, 1390, 1394, 1410, 1412, 1490, 1494 | 62/930-3 | K957340 | 12 V / 2,8 kW | 3x146  | 11Z 224 |
| 1594, 1690, 1694 | 62/930-15 62/930-161 Iskra | K308650 | 12 V / 3,5 kW 12 V / 3,1 kW | 3x146  | 10Z 254 231 |
| CASE-IH EUROPE | | | | | |
| 383, 423, 433, 453, 533, 633, 733, 833 | 62/930-21 62/930-55 Iskra | 3218674R91 3228192R91 | 12 V / 3,5 kW 12 V / 3,1 kW | 3x127  | 11Z 254 253 |
| 523, 553, 554, 624, 644, 654, 724, 743, 744, 745, 824, 844, 845, 856, 946, 955, 956, 1046, 1055, 1056, 1246, 1255, 1455 | 62/930-22 62/930-54 Iskra | 3218677R91 3228193R91 3229193R91 121905A1 | 12 V / 3,5 kW 12 V / 3,1 kW | 3x127  | 9Z 254 228 |
| 1255, 1455 | 62/930-167 Iskra | 82068C92 | 12 V / 3,6 kW | 3x127  | 9Z 323 |
| Maxxum 5120, 5130, 5140, 5150, MX 100, MX 110, MX 120, MX 135, MX 150, MX170 | 62/930-52 Iskra (Oilproof Retén de aceite) | 114799A1 | 12 V / 3,1 kW | 3x127  | 9Z 228 |
| CS 110, CS 120, CS 130, CS 150 | 62/930-43 Iskra | 132000090705 | 12 V / 3 kW | 3x127  | 11Z 243 |

 Part numbers are quoted for reference purposes only.
 Our parts and accessories are not original.

 Las referencias originales tienen un propósito identificativo.
 Nuestras piezas no son originales.

| | | | | |
|---|--------------------------|---------------------------|--------------|---|
|  | CASE-IH EUROPE | CASE-IH ENGLAND | CLAAS | STARTER MOTORS MOTORES DE ARRANQUE |
|---|--------------------------|---------------------------|--------------|---|

|  | Ref. Ref. | OEM OEM |  |  A x B |  Z |  L |
|---|----------------------------|------------------------|---|---|---|---|
| CASE-IH EUROPE | | | | | | |
| CX 50, CX 60 | 62/930-81 Iskra | 388186A1 | 12 V / 3 kW | 3x127  | 10Z | |
| CX 70, CX 80, CX 90, CX 100, MC 80, MC 90, MC 100 | 62/930-82 Iskra | 388187A1 | 12 V / 3 kW | 3x127  | 10Z | |
| | 62/930-80 Iskra | 234987A1 | 12 V / 2,8 kW |  | | 238 |
| CS 78, CS 86, CS 94 MWM Engine / Motor MWM | 62/930-32 Iskra | 130100090735 | 12 V / 2,7 kW | 3x127  | 9Z | 228 |
| CASE-IH ENGLAND | | | | | | |
| 275, 354, 374, 414, 434, 444 | 62/930-7 | 3046890R1 | 12 V / 3 kW | 3x127  | 10Z | 258 |
| 475 | 62/930-5 | 3116683R91 | 12 V / 3,5 kW | 3x127  | 10Z | 250 |
| 385, 395, 454, 474, 485, 495, 574, 584, 585, 595, 674, 684, 685, 695, 784, 785, 795, 884, 885, 895, 995, 3210, 3220, 3230, 4210, 4220, 4230, 4240 | 62/930-140 Iskra | 537140R92 529965R92 | 12 V / 3 kW | 3x127  | 10Z | 235 |
| | 62/930-13 | | 12 V / 2,8 kW |  | | |
| CLAAS | | | | | | |
| Consul, Dominator, Mercator Perkins Engine / Motor Perkins | 62/930-92 Iskra | 6853800 | 12 V / 2,7 kW | 2x105  | 11Z | 228 |
| Consul, Dominator, Jaguar, Mercator Mercedes Engine / Motor Mercedes | 62/930-76 Iskra | 6853810 | 12 V / 3 kW | 3x127  | 9Z | 242 |

Part numbers are quoted for reference purposes only.
Our parts and accessories are not original.

Las referencias originales tienen un propósito identificativo.
Nuestras piezas no son originales.



"THE RELIABLE SERVICE"















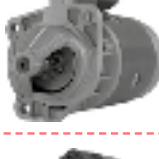

STARTER MOTORS
MOTORES DE ARRANQUE

KHD-DEUTZ

FENDT



|  | Ref. Ref. | OEM OEM |  |  A x B Z |  |
|--|----------------------------|--|--|---|---|
| KHD-DEUTZ | | | | | |
| FL712, FL812 Engines <i>Motores FL712, FL812</i> | 62/930-63 Iskra | | 12 V / 3 kW | 3x127  | 11Z 228 |
| FL912 Engine / <i>Motor FL912</i> 2 cylinders / <i>2 cilindros</i> | 62/930-28 Iskra | 01172683 01303970 | 12 V / 2,7 kW | 2x105  | 9Z 228 |
| Engines / <i>Motores</i> FL912, FL913, M1012, M1013 3, 4 & 5 cylinders / <i>3, 4 y 5 cilindros</i> | 62/930-31 Iskra | 01174166 01164668 01170051 | 12 V / 2,7 kW | 3x127  | 9Z 212 |
| | 62/930-68 | 01175886 01179586 | 12 V / 2,7 kW |  | 220 |
| | 62/930-23 Iskra | 01161384 01163669 01164994 01173240 | 12 V / 3 kW | 3x127  | 9Z 228 |
| | 62/930-165 Iskra | 01179318 01180805 | 12 V / 3,1 kW |  | 222 |
| Engines / <i>Motores</i> FL912, FL913, M1012, M1013 6 cylinders / <i>6 cilindros</i> | 62/930-29 Iskra | 01163758 | 12 V / 3,7 kW | 3x127  | 9Z 270 |
| Civil engineering / <i>Obras públicas</i> | 62/930-30 Iskra | 01164995 01173241 | 24 V / 4 kW | 3x127  | 9Z 262 |
| FENDT | | | | | |
| KHD FL912 Engine / <i>Motor KHD FL912</i> 3 and 4 cylinders / <i>3 y 4 cilindros</i> | 62/930-31 Iskra | X830100001000 6380900060010 | 12 V / 2,7 kW | 3x127  | 9Z 212 |
| | 62/930-68 | | 12 V / 2,7 kW |  | 220 |
| KHD FL912 Engine / <i>Motor KHD FL912</i> 3 and 4 cylinders / <i>3 y 4 cilindros</i> | 62/930-23 Iskra | X830100007000 | 12 V / 3 kW | 3x127  | 9Z 228 |

Part numbers are quoted for reference purposes only.
Our parts and accessories are not original.





Las referencias originales tienen un propósito identificativo.
Nuestras piezas no son originales.



"THE RELIABLE SERVICE"



FENDT **FIATAGRI NEW HOLLAND** **STARTER MOTORS**
MOTORES DE ARRANQUE

|  | Ref. Ref. | OEM OEM |  |  A x B |  Z |  L |
|---|---|--|---|---|---|---|
| FENDT | | | | | | |
| MWM Engines / Motores MWM D208, D225, D325 | 62/930-28 Iskra | F139900060011 | 12 V / 2,7 kW | 2x105 | 9Z | 228 |
| MWM D226, D227 Engines Motores MWM D226, D227 3 cylinders / 3 cilindros | 62/930-32 Iskra | F13590206001 X830100009000 | 12 V / 2,7 kW | 3x127 | 9Z | 228 |
| MWM D226, D227 Engines Motores MWM D226, D227 4 and 6 cylinders / 4 y 6 cilindros | 62/930-26 62/930-56 Iskra | X830100004000 G514900060100 | 12 V / 3,5 kW 12 V / 3,1 kW | 3x127 | 9Z | 254 240 |
| MAN Engine / Motor MAN 800 and 900 serie Serie 800 y 900 | 62/930-166 Iskra | F524900060010 | 24 V / 4 kW | 3x127 | 11Z | 265 |
| FIATAGRI NEW HOLLAND | | | | | | |
| Old range / Gama antigua 24 V. assembly / Equipos de 24 V. | 62/930-164 Iskra | 4691200 4706931 4807377 6706931 77050561 | 24 V / 3,2 kW | 3x146 | 9Z | 223 |
| Som 50, 55 611, 612, 615, 715 | 62/930-33 | 44008814 | 12 V / 3 kW | | 9Z | 370 |
| 650, 750, 850 OM Engine / Motor OM | 62/930-34 Iskra | 8962211 8962407 44014764 | 12 V / 3 kW | 3x127 | 9Z | 385 |
| 800, 805, 880/4, 1300 OM Engine / Motor OM | 62/930-35 | 4712894 4713805 4737758 | 12 V / 3,5 kW | 3x127 | 9Z | 238 |

Part numbers are quoted for reference purposes only.
Our parts and accessories are not original.

Las referencias originales tienen un propósito identificativo.
Nuestras piezas no son originales.













"THE RELIABLE SERVICE"



STARTER MOTORS
MOTORES DE ARRANQUE
FIATAGRI
 NEW HOLLAND

FERMEC
FORD
 NEW HOLLAND













|  | Ref. Ref. | OEM OEM |  |  A A x B B | Z |  L |
|--|----------------------------|---|--|---|-----|---|
| FIATAGRI NEW HOLLAND | | | | | | |
| 400, 420, 446, 450, 466, 470, 480, 500, 540, 566, 570, 45-66, 50-66, 55-46, 55-66, 55-76, 55-86, 55-88, 55-90, 60-46, 60-66, 60-76, 60-88, 60-90, 60-93, 60-94, 92-86 | 62/930-91 Iskra | 4169096 4172113 4682998 | 12 V / 2,7 kW | 3x146 | 9Z | 223 |
| | 62/930-77 | 4710224 4722682 4759929 4807373 88205005 | 12 V / 2,5 kW |  | | 223 |
| 460, 488, 550, 580, 600, 640, 670, 680, 780, 880, 900, 1000, 65-46, 65-66, 65-88, 65-90, 65-93, 65-94, 70-66, 70-76, 70-88, 70-90, 72-93, 72-94, 80-66, 80-76, 80-88, 80-90, 82-93, 82-94, 85-90, 88-93, 88-94, L60, L65, L75, L85, L95, TL70, TL80, TL90, TL100 | 62/930-88 Iskra | 4699705 4737755 4755109 | 12 V / 3 kW | 3x146 | 9Z | 262 |
| | 62/930-24 | 4169093 4692478 4702248 88206006 4807375 4832942 | 12 V / 3,5 kW |  | | 242 |
| 550, 600, 640 1 st serie / 1 ^{er} serie 880/5 (9/82 ⇔) | 62/930-97 Iskra | 4713806 4737759 4755110 | 12 V / 3 kW | 3x146 | 9Z | 310 |
| 980, 1180, 1280, 1380, 1580, 1880, 90-90, 100-90, 110-90, 115-90, 130-90, 140-90, 160-90, 180-90 F100, F110, F115, F120, F130, F140 | 62/930-36 | 4807376 4719666 | 12 V / 3,5 kW |  | | 250 |
| FERMEC | | | | | | |
| 640B, 650B, 660B, 750, 760, 860, 960, 965 | 62/930-82 Iskra | | 12 V / 3 kW | 3x127 | 10Z | |
| | | | |  | | |
| FORD NEW HOLLAND | | | | | | |
| Major, Super Major | 62/930-2 (A) | E1HDDN11000D 81712422 | 12 V / 3,5 kW | 3x146 | 10Z | 240 |
| | | | |  | | |
| 2000, 2310, 2600, 2610, 3000, 3600, 3610 | 62/930-160 Iskra | E3NN11000AA 83943890 | 12 V / 2,8 kW | 3x146 | 10Z | 252 |
| | 62/930-8 | | 12 V / 2,5 kW |  | | 238 |

(A) To fit with a start knob / Montar botón de arranque

 Part numbers are quoted for reference purposes only.
 Our parts and accessories are not original.

 Las referencias originales tienen un propósito identificativo.
 Nuestras piezas no son originales.

| | | | | |
|---|----------------------------|------------------|------------|---|
|  | FORD NEW HOLLAND | HÜRLIMANN | JCB | STARTER MOTORS MOTORES DE ARRANQUE |
|---|----------------------------|------------------|------------|---|

|  | Ref. Ref. | OEM OEM |  |  A x B |  Z |  L |
|---|----------------------------|---|---|---|---|---|
| FORD NEW HOLLAND | | | | | | |
| 2810, 2910, 3230, 3430, 3900, 3910, 3430, 4000, 4100, 4110, 4130, 4600, 4610, 4630, 4830, 5000, 5030, 5110, 5600, 5610, 5610S, 5640, 5700, 5900, 6410, 6600, 6610, 6610S, 6640, 6700, 6710, 6810, 6810S, 7000, 7010, 7410, 7600, 7610, 7610S, 7740, 7700, 7710, 7810, 7810S, 7840, 7910, 8000, 8010, 8160, 8200, 8210, 8240, 8260, 8340, 8360, 8530, 8560, 8600, 8630, 8700, 8730, 8830, 9000, 9200, 9600, 9700, TS80, TS90, TS100, TS110, TS115, TW5, TW10, TW15, TW20, TW25, TW30, TW35 | 62/930-161 Iskra | D8NN11000CE 83981923 82005342 82007917 82013922 | 12 V / 3,1 kW | 3x146 |  | 10Z 250 |
| | 62/930-9 | | 12 V / 3,5 kW | | | 254 |
| | 62/930-170 Iskra | F1NN11000AA 81868126 82005343 82013923 | 12 V / 3,6 kW | | | 250 |
| 4230, 4430, 4635, 4835, 5635, 6635, 7635 | 62/930-88 Iskra | 4755109 4807375 4832942 | 12 V / 3 kW | 3x146 |  | 9Z 262 |
| | 62/930-24 | 88205006 | | | | 242 |
| HÜRLIMANN | | | | | | |
| H305, H306, H361, H476 XF, XA606, XA656, XN706, XN707 | 62/930-92 Iskra | 296190800 296193600 296193700 | 12 V / 2,7 kW | 2x105 |  | 11Z 228 |
| | 62/930-37 | | 12 V / 2,5 kW | | | 224 |
| H345, H355, H358, H360, H470, H476, H480, H488, H490, H496, H5110, H5116, H6115, H6130, H6135, H6136, H6160, H6165, H6190 | 62/930-94 Iskra | 296191800 | 12 V / 3 kW | 2x105 |  | 11Z 259 |
| | 62/930-125 | | 12 V / 3,5 kW | | | 254 |
| H356, H466, H468, H478, H481, H491, 6115 Elite, 6135 Elite, H6165 DT, H6190 DT, XA607, XN708, XN709, XT908, XT909, XT910.4, XT910.6 | 62/930-60 Iskra | 296192300 296193500 | 12 V / 3 kW | 2x105 |  | 9Z 259 |
| | 62/930-126 | | 12 V / 3,5 kW | | | 254 |
| JCB | | | | | | |
| 110, 413, 418, 702, 704, 805, 805B, 806, 806B, 807, 807B, 808, 902, 1250, SL702P, SL704P, SL900P, SL1000P, SL1500P, SL1750P | 62/930-80 Iskra | | 12 V / 2,8 kW | 3x127 |  | 10Z 238 |
| | 62/930-5 | | 12 V / 3,5 kW | | | 250 |
| 3CX4, 4CX, 420, 430, 807C, 811, 812, 814, 817, 818, 820, Fastrac 125, 135, 145, 155, 185, 1115, 1135 | 62/930-38 Iskra | 71429300R 71429500R | 12 V / 2,8 kW | 3x127 |  | 10Z 237 |

Part numbers are quoted for reference purposes only.
Our parts and accessories are not original.

Las referencias originales tienen un propósito identificativo.
Nuestras piezas no son originales.



"THE RELIABLE SERVICE"













STARTER MOTORS
MOTORES DE ARRANQUE

JCB

JOHN-DEERE

LAMBORGHINI















|  | Ref. Ref. | OEM OEM |  |  A x B Z |  |
|---|--|---|--|--|---|
| JCB | | | | | |
| 805 (1/76 ⇒) 806, 806B, 807B (⇒ 1/82) | 62/930-160 Iskra | | 12 V / 2,8 kW | 3x146  | 10Z 237 |
| JOHN-DEERE | | | | | |
| 10, 20, 30, 40, 50 Series / Series, 6010, 6110, 6210, 6310, 6410, 6100, 6200, 6300, 6400 | 62/930-86 Iskra 62/930-25 | AL110503 AL110504 AL62772 AL78760 AL70850 AL110597 AR70436 RE500733 RE60384 | 12 V / 3,1 kW 12 V / 3,5 kW | 2x105  | 10Z 241 250 |
| 6500, 6600, 6800, 6900 6510, 6610, 6810, 6910 | 62/930-58 Iskra | AL70852 AL81154 | 12 V / 3,1 kW | 3x127  | 10Z 241 |
| LAMBORGHINI | | | | | |
| 503, 603 | 62/930-28 Iskra | | 12 V / 3,1 kW | 2x105  | 9Z 228 |
| 554, 564, 574, 660, 770, C352, C503, C554, C603, C664, R235, R550, R574 | 62/930-92 Iskra 62/930-37 | 296190800 296193600 296193700 | 12 V / 2,7 kW 12 V / 2,5 kW | 2x105  | 11Z 228 224 |
| C603, R704, R804, R904, R360, R470, R480 | 62/930-159 Iskra | 296191500 296191100 | 12 V / 3 kW | 3x127  | 11Z 228 |
| 345, 573, 574, 654, 674, 684, 754, 774, 775, 874, C684, C754, C784, R613, R653, R684, R714, R724, R754, R854, R955, R1056, 1356, 1556, Formula 115, 135, Racing 165, 190 | 62/930-94 Iskra 62/930-125 | 296191800 | 12 V / 3 kW 12 V / 3,5 kW | 2x105  | 11Z 259 254 |

Part numbers are quoted for reference purposes only.
Our parts and accessories are not original.

Las referencias originales tienen un propósito identificativo.
Nuestras piezas no son originales.



LAMBORGHINI **LANDINI** **LAVERDA** **STARTER MOTORS**
MOTORES DE ARRANQUE

|  | Ref. Ref. | OEM OEM |  |  A x B |  Z |  L | |
|---|---------------------------|-------------------------------|---|---|---|---|-----|
| LAMBORGHINI | | | | | | | |
| 660, 674-70, 774-80, 775, 874-90, 880, 950, C674-70, C774-80, C874-90, R956, R1106, R1306, R1706, Formula 105, 115, 135, Premium 1050, 1060, Racing 150, 165, 190 | 62/930-60 Iskra | 296192300 296193500 | 12 V / 3 kW | 2x105 |  | 9Z | 259 |
| | 62/930-126 | | 12 V / 3,5 kW | | | 254 | |
| LANDINI | | | | | | | |
| Perkins Engines / Motores Perkins A3-152, AD3-152 | 62/930-90 Iskra | 3542184M91 3546390M91 | 12 V / 2,7 kW | 3x146 |  | 10Z | 223 |
| | 62/930-4 | | 12 V / 2,7 kW | | | 220 | |
| Perkins Engines / Motores Perkins A4-203, AD4-203 | 62/930-87 Iskra | 3597371M2 | 12 V / 2,8 kW | 3x146 |  | 10Z | 240 |
| | 62/930-10 | | 12 V / 3,5 kW | | | 254 | |
| Perkins Engines / Motores Perkins A4-212, A4-236, A4-248, A6-354 | 62/930-80 Iskra | 3542185M91 3546391M91 | 12 V / 2,8 kW | 3x127 |  | 10Z | 238 |
| | 62/930-5 | | 12 V / 3,5 kW | | | 254 | |
| | 62/930-11 | | 12 V / 3 kW | | | | |
| Perkins Engine / Motor Perkins 1000 serie / Serie 1000 | 62/930-38 Iskra | 3551773M91 3648190M91 | 12 V / 2,8 kW | 3x127 |  | 10Z | 237 |
| LAVERDA | | | | | | | |
| M152 OM Engine / Motor OM | 62/930-35 | 4712894 4713805 4737758 | 12 V / 3,5 kW | 3x127 |  | 9Z | 238 |
| M112, M132, 3300, 3350, 3450, 3550, 3600, 3650, 3750, L517 | 62/930-88 Iskra | 4699705 4807375 4832942 | 12 V / 3 kW | 3x146 |  | 9Z | 262 |
| | 62/930-24 | | 12 V / 3,5 kW | | | 242 | |

Part numbers are quoted for reference purposes only.
Our parts and accessories are not original.

Las referencias originales tienen un propósito identificativo.
Nuestras piezas no son originales.



"THE RELIABLE SERVICE"











STARTER MOTORS
MOTORES DE ARRANQUE

LAVERDA

MASSEY
FERGUSON



|  | Ref. Ref. | OEM OEM |  |  A x B Z |  | |
|--|---------------------------|---|--|---|---|-----|
| LAVERDA | | | | | | |
| 3700, 3790, 3850, 3890, L521, L524, L624 | 62/930-97 Iskra | 4713806 4737759 4807376 4719666 | 12 V / 3 kW | 3x146 | 9Z | 310 |
| | 62/930-36 | | 12 V / 3,5 kW |  | | 250 |
| MASSEY-FERGUSON | | | | | | |
| Standard engines / <i>Motores estándar</i> Petrol / <i>Gasolina</i> TE20, FE35 | 62/930-1 | L25038 | 12 V / 1,8 kW | 2x127 | 9Z | 168 |
| Standard engines / <i>Motores estándar</i> Diesel / <i>Diesel</i> 20C, 23C, TEF20, 30, 35 | 62/930-3 | 26133 26278 | 12 V / 2,8 kW | 3x146 | 11Z | 224 |
| Perkins Engines / <i>Motores Perkins</i> A3-152, AD3-152, A4-192, A4-203, AD4-203 65, 133, 134, 135, 140, 145, 148, 152, 154, 155, 158, 165/II, 230, 233, 234, 235, 240, 245, 250, 253, 254, 255, 260, 263, 264, 350, 353, 355, 360 363, 364, 550, 560 | 62/930-90 Iskra | 1680065M3 1868283M5 | 12 V / 2,7 kW | 3x146 | 10Z | 223 |
| | 62/930-4 | 3597371M1 3597426M3 3763363M91 | 12 V / 2,7 kW |  | | 220 |
| | 62/930-87 Iskra | | 12 V / 2,8 kW | | | 240 |
| | 62/930-10 | | 12 V / 3,5 kW | | | 254 |
| Perkins Engines / <i>Motores Perkins</i> A4-212, A4-236, A4-248, A4-318, A6-354 165/III, 168, 174, 175, 178, 184, 185, 188, 194, 265, 273, 274, 275, 283, 284, 285, 290, 293, 294, 298, 362, 365, 373, 374, 375, 377, 383, 384, 387, 390, 393, 394, 397, 398, 399, 565, 575, 590, 592, 595, 675, 690, 698, 699, 1004, 1014, 1080, 1114, 3050, 3060, 3065, 3070, 3075, 4225, 4235, 4240, 4245, 4255, 4260, 4270, 6110, 6120, 6130, 6140, 6150 | 62/930-80 Iskra | 1860093M2 1868285M3 2873006M1 | 12 V / 2,8 kW | 3x127 | 10Z | 238 |
| | 62/930-5 | 1447301M91 3597372M1 1447731M1 3763362M91 1680064M1 | 12 V / 3,5 kW |  | | 254 |
| | 62/930-11 | | 12 V / 3 kW | | | |
| 2620, 2625, 2640, 2645, 2680, 2685, 2720, 2725, 3080, 3090, 3610, 3630, 3650 | 62/930-16 Iskra | 1618050M4 3637269R91 | 12 V / 2,8 kW | 3x127 | 10Z | 228 |
| 3085, 3095, 3115, 3125, 3635, 3645, 3655, 3670, 3680, 3690, 6160, 6170, 6180, 6190, 6410, 6510, 6710, 6810, 6260, 6270, 6280, 6290, 8110, 8120, 8130, 8140, 8150, 8160, 8210, 8220, 8240, 8250 | 62/930-38 Iskra | 3581576M2 1447732M1 | 12 V / 2,8 kW | 3x127 | 10Z | 237 |
| | 62/930-104 | | 12 V / 3 kW |  | | |

Part numbers are quoted for reference purposes only.
Our parts and accessories are not original.













Las referencias originales tienen un propósito identificativo.
Nuestras piezas no son originales.



"THE RELIABLE SERVICE"



| | | | | | |
|---|-------------------|----------------|-----------------------|-----------------------|---|
|  | Mc CORMICK | MB-TRAC | MINSK TRACTORS | RENAULT D.M.A. | STARTER MOTORS MOTORES DE ARRANQUE |
|---|-------------------|----------------|-----------------------|-----------------------|---|

|  | Ref. Ref. | OEM OEM |  |  A x B |  Z |  L |
|---|----------------------------|--|---|---|---|---|
| Mc CORMICK | | | | | | |
| CX50, CX60 | 62/930-81 Iskra | 388186A1 | 12 V / 3 kW | 3x127 |  | 10Z |
| CX70, CX80, CX90, CX100, MC80, MC90, MC100 | 62/930-82 Iskra | 388187A1 | 12 V / 3 kW | 3x127 |  | 10Z |
| MB-TRAC | | | | | | |
| 700, 800, 900, 1000, 1100, 1300, 1400, 1500, 1600 | 62/930-76 Iskra | 0031510501 0031517301 0031518701 0041512201 | 12 V / 3 kW | 3x127 |  | 9Z 231 |
| MINSK TRACTORS BELARUS | | | | | | |
| MTZ 80, 82, 510, 512, 520, 522, 530, 532, 550, 552, 570, 572, 590, 592, 800, 820, 900, 920, 922, 950, 952, 1005, 1025 | 62/930-168 Iskra | 24073708000 | 12 V / 3 kW | 3x146 |  | 10Z 259 |
| RENAULT D.M.A. | | | | | | |
| MWM 325-2 Engine Motor MWM 325-2 | 62/930-28 Iskra | | 12 V / 2,7 kW | 2x105 |  | 9Z 228 |
| Engines / Motores D226, 227, 325, 327 | 62/930-32 Iskra | 7700046893 7700627394 7700026780 6005011729 7700501670 | 12 V / 2,7 kW | 3x127 |  | 9Z 228 |
| | 62/930-56 Iskra | 6005701125 | 12 V / 3,1 kW | | | 240 |
| | 62/930-26 | 7700519797 7700525547 | 12 V / 3,5 kW | | | 254 |
| Perkins Engines / Motores Perkins Super 7, Super 7D | 62/930-39 | 0854324900 | 12 V / 3,5 kW | 3x127 |  | 10Z 254 |

Part numbers are quoted for reference purposes only.
Our parts and accessories are not original.

Las referencias originales tienen un propósito identificativo.
Nuestras piezas no son originales.



"THE RELIABLE SERVICE"



STARTER MOTORS
MOTORES DE ARRANQUE

RENAULT
D.M.A.



| | Ref. Ref. | OEM OEM | | A x B Z | | |
|---|---------------------------|--|---------------|---------|-----|-----|
| RENAULT D.M.A. | | | | | | |
| Perkins Engines / Motores Perkins 3-152, 4-203 | 62/930-90 Iskra | 6005700082 6005007548 7701028780 | 12 V / 2,7 kW | 3x146 | 10Z | 214 |
| | 62/930-4 | | 12 V / 2,7 kW | | | 220 |
| | 62/930-10 | | 12 V / 3,5 kW | | | 254 |
| Perkins Engines / Motores Perkins 4-236, 4-248 | 62/930-80 Iskra | 7701031686 6005700081 6005003154 6005021272 | 12 V / 2,8 kW | 3x127 | 10Z | 238 |
| | 62/930-5 | | 12 V / 3,5 kW | | | 250 |
| Deutz Engines / Motores Deutz FL912, FL913 | 62/930-23 Iskra | 6005016395 6000103270 6000102270 | 12 V / 3 kW | 3x127 | 9Z | 228 |
| | 62/930-68 | | 12 V / 2,7 kW | | | 220 |
| DPSG Engine / Motor DPSG Ceres 310, 320, 330, 340, Cergos 330, 340, 350, Ergos 85, 95, 105 | 62/930-86 Iskra | 6005012976 6005022635 | 12 V / 3,1 kW | 2x105 | 10Z | 241 |
| DPSG Engine / Motor DPSG Ares 540, 550, 610, 620, 630, 640 | 62/930-58 Iskra | 7700044450 7700045291 | 12 V / 3,1 kW | 3x127 | 10Z | 228 |
| DPSG Engine / Motor DPSG Ares 710, 720, 725, 735, 815, 825, Temis 550 | 62/930-59 Iskra | 7700047132 | 12 V / 3,1 kW | 2x105 | 10Z | 241 |
| IVECO Engine / Motor IVECO Temis 610, 630, 650 | 62/930-98 Iskra | 7700052677 | 12 V / 3 kW | 3x146 | 9Z | |

Part numbers are quoted for reference purposes only.
Our parts and accessories are not original.













Las referencias originales tienen un propósito identificativo.
Nuestras piezas no son originales.



"THE RELIABLE SERVICE"



 **SAME** **STEYR** **STARTER MOTORS**
MOTORES DE ARRANQUE

|  | Ref. Ref. | OEM OEM |  |  A x B |  Z |  L |
|---|----------------------------|-------------------------------------|---|---|---|---|
| SAME | | | | | | |
| Argon 50, 60, 70, Delfino 35, Dorado 60, Frutteto 60, Golden 60, Saturno 80, Sirenetta 35, Solar 50, 55, Vigneron 62 | 62/930-92 Iskra | 296190800 296193600 296193700 | 12 V / 2,7 kW | 2x105 |  | 11Z 228 |
| | 62/930-37 | | 12 V / 2,5 kW | | | 224 |
| Antares 110, 130, Aurora 45, Buffalo 130, Centauro 70, Centurion 75, Condor 55, Corsaro 70, Drago 120, Explorer 55, 65, 75, 85, Falcon, Frutteto 75, Galaxy 170, Hercules 160, Jaguar 95, 100, Laser 90, 100, 110, 130, 150, Leopard 85, 90, Mercury 85, Minitauro 60, Minitaurus 60, Panther 90, 95, Saturno 80, Solar 60, Taurus 60, Tiger 100, Tiger 51 x 105, Titan 160, 190, Vigneron 60, 70 | 62/930-94 Iskra | 296191800 | 12 V / 3 kW | 2x105 |  | 11Z 259 |
| | 62/930-125 | | 12 V / 3,5 kW | | | 254 |
| Antares 110, 130, Dorado 70, Explorer 70, 80, 90, Frutteto 75, 85, Golden 75, 85, Laser 100, 110, 130, 150, Silver 80, 90, 100, Titan 145, 160 DT, 190 DT, Vigneron 75 | 62/930-60 Iskra | 296192300 296193500 | 12 V / 3 kW | 2x105 |  | 9Z 259 |
| | 62/930-126 | | 12 V / 3,5 kW | | | 254 |
| Buffalo 120, Drago, Panther | 62/930-159 Iskra | 296191500 296191100 | 12 V / 3 kW | 3x127 |  | 11Z 228 |
| STEYR | | | | | | |
| old range / <i>Gama antigua</i> | 62/930-92 Iskra | | 12 V / 2,7 kW | 2x105 |  | 11Z 228 |
| | 62/930-37 | | 12 V / 2,5 kW | | | 224 |
| 288, 290, 406, 545, 650, 658, 760, 768, 988 | 62/930-94 Iskra | 40800090010 | 12 V / 3 kW | 2x105 |  | 11Z 259 |
| | 62/930-125 | | 12 V / 3,5 kW | | | 254 |
| 780, 870, 1090, 1100, 1200 | 62/930-159 Iskra | 409090001 | 12 V / 3 kW | 3x127 |  | 11Z 228 |

Part numbers are quoted for reference purposes only.
Our parts and accessories are not original.

Las referencias originales tienen un propósito identificativo.
Nuestras piezas no son originales.



"THE RELIABLE SERVICE"













STARTER MOTORS
MOTORES DE ARRANQUE

STEYR

UNIVERSAL
U.T.B.















|  | Ref. Ref. | OEM OEM |  |  A x B Z |  |
|---|---|------------------------------|--|---|---|
| STEYR | | | | | |
| 950, 960, 8055, 8060, 8070, 8075, 8080, 8090 | 62/930-40 Iskra | | 12 V / 3 kW | 2x105  | 9Z 270 |
| 980, 988, 1100, 1108, 1200, 8140, 8150, 8160, 8165, 8170 | 62/930-169 Iskra | 41200090001 41200090004 | 12 V / 3 kW | 3x127  | 9Z 243 |
| 8100, 8110, 8120, 8130 | 62/930-60 Iskra 62/930-126 | 41100090005 | 12 V / 3 kW 12 V / 3,5 kW | 2x105  | 9Z 259 254 |
| 9078, 9083, 9086, 9094 MWM Engine / Motor MWM | 62/930-32 Iskra | 130100090735 | 12 V / 2,7 kW | 3x127  | 9Z 228 |
| 9105, 9115, 9125, 9145 Valmet Engine / Motor Valmet | 62/930-43 Iskra | 132000090705 | 12 V / 3 kW | 3x127  | 11Z 243 |
| 9155, 9170, 9190 Perkins Engine / Motor Perkins | 62/930-38 Iskra | | 12 V / 2,8 kW | 3x127  | 10Z 237 |
| UNIVERSAL U.T.B. | | | | | |
| 350, 400, 420, 445, 450, 470, 480, 530, 533, 550, 640, 643, 703 | 62/930-163 Iskra 62/930-41 Iskra | 213000 5142733 5111319 | 12 V / 2,7 kW 12 V / 3 kW | 3x146  | 9Z 223 252 |

Part numbers are quoted for reference purposes only.
Our parts and accessories are not original.

Las referencias originales tienen un propósito identificativo.
Nuestras piezas no son originales.



 **URSUS** **VALMET** **VOLVO** **STARTER MOTORS**
MOTORES DE ARRANQUE

|  | Ref. Ref. | OEM OEM |  |  A x B |  Z |  L |
|---|---------------------------|-------------------|---|---|---|---|
| URSUS | | | | | | |
| 912, 914, 1114, 1134, 1614, | 62/930-48 | | 12 V / 2,9 kW | 3x127  | 11Z | 230 |
| 4514 Perkins Engine / Motor Perkins | 62/930-5 | | 12 V / 3,5 kW | 3x127  | 10Z | 250 |
| VALMET | | | | | | |
| 305, 405, 455, 502, 504, 505, 602, 604, 605, 655, 700, 702, 703, 705, 712, 755, 802, 803, 805, 855, 900, 902, 903, 905, 1100, 1102, 1112, 1203, 6000 | 62/930-43 Iskra | 835331592 | 12 V / 3 kW | 3x127  | 11Z | 243 |
| 255, 355, 365, 465, 504, 565, 604, 665, 865, 6100, 6300, 6400, 6600, 6800, 8000, 8050, 8100, 8200, 8150, 8400, 8450, 8550, 8750, C15, C20, C100, C200 | 62/930-44 Iskra | 836640940 | 12 V / 3 kW | 3x127  | 10Z | 243 |
| VOLVO | | | | | | |
| Perkins Engine / Motor Perkins BM 500, BM 2200, 2204, 2250, 2254 | 62/930-80 Iskra | | 12 V / 2,8 kW | 3x127  | 10Z | 238 |
| 320, 430 | 62/930-45 | | 12 V / 3 kW | 3x127  | 11Z | 380 |
| BM 320, 400, 430, 505, 605, 620, 640, 650, 700, 705, 840, BM Boxer 350, 600, S950, SM668, T800, T810, T814, LM 620, LM 640 | 62/930-46 Iskra | 240524 7240524 | 12 V / 3 kW | 3x127  | 9Z | 380 |
| BM 805 | 62/930-44 Iskra | | 12 V / 3 kW | 3x127  | 10Z | 243 |

Part numbers are quoted for reference purposes only.
Our parts and accessories are not original.

Las referencias originales tienen un propósito identificativo.
Nuestras piezas no son originales.



"THE RELIABLE SERVICE"



STARTER MOTORS
MOTORES DE ARRANQUE

ZETOR



| | Ref. Ref. | OEM OEM | | A x B Z | L |
|--|--|------------------------------|---------------|---------|---------|
| ZETOR | | | | | |
| 2 cylinders / 2 cilindros 2011, 2511 | 62/930-171 With reducer and intermediate flange <i>Con reductor y pestaña intermedia</i> | 69185771 | 12V | 3x127 | 11Z 185 |
| 3011, 3045, 3320, 3340, 3511, 3513, 3545, 4320, 4321, 4340, 4341, 4511, 4611, 4712, 4718, 4911, 5011, 5211, 5245, 5320, 5321, 5340, 5341, 5511, 5545, 5516, 5611, 5645, 5647, 5711, 5718, 5745, 5748, 5911, 5945, 6011, 6045, 6211, 6212, 6245, 6320, 6321, 6340, 6341, 6511, 6518, 6522, 6711, 6718, 6745, 6748, 6911, 6918, 6945, 7011, 7045, 7211, 7245, 7320, 7321, 7340, 7341, 7711, 7745 | 62/930-137 | 69185771 976111 976116 | 12 V / 3 kW | 3x127 | 11Z 231 |
| | 62/930-43 Iskra | 976117 | 12 V / 3 kW | | 243 |
| | 62/930-75 With reducer <i>Con reductor</i> | 69185771 | 12V | 3x127 | 11Z 185 |
| 7520, 7540, 8520, 8540, 9520, 8540, 10520, 10540 | 62/930-47 | 78350925 | 12 V / 3,5 kW | | 9Z 230 |
| 8011, 8045, 8111, 8145, 8211, 8245, 9211, 9245, 10011, 10045, 10111, 10145, 10211, 10245 | 62/930-48 | 80357918 9144742 | 12 V / 2,9 kW | 3x127 | 11Z 230 |
| | 62/930-159 Iskra | | 12 V / 3 kW | | 228 |
| 8111, 8145, 8211, 8245, 9111, 9145, 9211, 9245, 10111, 10145, 10211, 10245 | 62/930-49 | 83359918 | 24 V / 3,3 kW | 3x127 | 11Z 232 |
| 11211, 11245, 12011, 12045, 12111, 12145, 12211, 12245, 14145, 14245, 16045, 16145, 16245 | 62/930-51 | 93350726 86350913 | 24 V / 6,5 kW | | 11Z 335 |

Part numbers are quoted for reference purposes only.
Our parts and accessories are not original.

Las referencias originales tienen un propósito identificativo.
Nuestras piezas no son originales.



STARTER MOTORS
MOTORES DE ARRANQUE
ORDER N° - OLD REF. - CROSS-REFERENCE
REF. No - ANT. REF. - LISTA DE REFERENCIAS CRUZADAS

| Order N° Ref. No | Old Ref. Ant. Ref. | Page Página | Order N° Ref. No | Old Ref. Ant. Ref. | Page Página | Order N° Ref. No | Old Ref. Ant. Ref. | Page Página | Order N° Ref. No | Old Ref. Ant. Ref. | Page Página |
|---------------------|-----------------------|----------------|---------------------|-----------------------|----------------|---------------------|-----------------------|----------------|---------------------|-----------------------|----------------|
| 930-1 | LU25038 | 9 | 930-29 | K116/3758 | 3 | 930-52 | - | 1 | 930-94 | - | 6,7,12 |
| 930-2 | FD11000 | 5 | 930-30 | K073-24 | 3 | 930-54 | 15/00704 | 1 | 930-97 | - | 5,9 |
| 930-3 | LUR/26278 | 1,9 | 930-31 | XF117 | 3 | 930-55 | 15/00705 | 1 | 930-98 | - | 11 |
| 930-4 | LU26206 | 8,9,11 | 930-32 | XF130100 | 2,4,10,13 | 930-56 | 15/00706 | 4,10 | 930-104 | - | 9 |
| 930-5 | LUR/26271 | 2,6,8,9,11,14 | 930-33 | SF8814 | 4 | 930-58 | RR44450 | 7,11 | 930-125 | SLT9619/110 | 6,7,12 |
| 930-6 | K957341 | 1 | 930-34 | SF8962407 | 4 | 930-59 | RR47132 | 11 | 930-126 | S9619/180N | 6,8,12,13 |
| 930-7 | 15/00208IH | 2 | 930-35 | FA4737758 | 4,8 | 930-60 | S9619/180NIS | 6,8,12,13 | 930-137 | ZR6918 | 15 |
| 930-8 | FNN11000 | 5 | 930-36 | FA4737759 | 5,9 | 930-63 | - | 3 | 930-140 | R537140 | 2 |
| 930-9 | FD8/11000AA | 6 | 930-37 | S9619/080 | 6,7,12 | 930-68 | K117/4166 | 3,11 | 930-159 | - | 7,12,15 |
| 930-10 | LUR/26264 | 8,9,11 | 930-38 | LUR/27570 | 6,8,9,13 | 930-75 | 69185771N | 15 | 930-160 | - | 5,7 |
| 930-11 | - | 8,9 | 930-39 | RR8543249 | 10 | 930-76 | 15/30412 | 2,10 | 930-161 | - | 1,6 |
| 930-13 | - | 2 | 930-40 | 15/00671ST | 13 | 930-77 | SF4807373 | 5 | 930-163 | - | 13 |
| 930-15 | K308650 | 1 | 930-41 | UTB127 | 13 | 930-80 | - | 2,6,8,9,11,14 | 930-164 | - | 4 |
| 930-16 | M1618050 | 9 | 930-43 | 15/00692V | 1,13,14,15 | 930-81 | - | 2,10 | 930-165 | - | 3 |
| 930-21 | 15/00506IH | 1 | 930-44 | LRS147 | 14 | 930-82 | - | 2,5,10 | 930-166 | - | 4 |
| 930-22 | R3055414 | 1 | 930-45 | VBM521 | 14 | 930-86 | 15/70436AR | 7,11 | 930-167 | - | 1 |
| 930-23 | K073 | 3,11 | 930-46 | VBM500 | 14 | 930-87 | - | 8,9 | 930-168 | - | 10 |
| 930-24 | SF4737755 | 5,6,8 | 930-47 | 78350925 | 15 | 930-88 | - | 5,6,8 | 930-169 | - | 13 |
| 930-25 | 15/06804JD | 7 | 930-48 | ZR976116 | 14,15 | 930-90 | - | 8,9,11 | 930-170 | - | 6 |
| 930-26 | RR519797 | 4,10 | 930-49 | ZR83359918 | 15 | 930-91 | - | 5 | 930-171 | - | 15 |
| 930-28 | SLT2040 | 3,4,7,10 | 930-51 | Z86350913 | 15 | 930-92 | - | 2,6,7,12 | | | |

OLD REF. - ORDER N° - CROSS-REFERENCE
ANT. REF. - REF No - LISTA DE REFERENCIAS CRUZADAS

| Old Ref. Ant. Ref. | Order N° Ref. No | Page Página | Old Ref. Ant. Ref. | Order N° Ref. No | Page Página | Old Ref. Ant. Ref. | Order N° Ref. No | Page Página | Old Ref. Ant. Ref. | Order N° Ref. No | Page Página |
|-----------------------|---------------------|----------------|-----------------------|---------------------|----------------|-----------------------|---------------------|----------------|-----------------------|---------------------|----------------|
| 15/00208IH | 930-7 | 2 | K308650 | 930-15 | 1 | SF8814 | 930-33 | 4 | - | 930-88 | 5,6,8 |
| 15/00506IH | 930-21 | 1 | K957341 | 930-6 | 1 | SF8962407 | 930-34 | 4 | - | 930-90 | 8,9,11 |
| 15/00671ST | 930-40 | 13 | LRS147 | 930-44 | 14 | SLT2040 | 930-28 | 3,4,7,10 | - | 930-91 | 5 |
| 15/00692V | 930-43 | 1,13,14,15 | LU25038 | 930-1 | 9 | SLT9619/110 | 930-125 | 6,7,12 | - | 930-92 | 2,6,7,12 |
| 15/00704 | 930-54 | 1 | LU26206 | 930-4 | 8,9,11 | UTB127 | 930-41 | 13 | - | 930-94 | 6,7,12 |
| 15/00705 | 930-55 | 1 | LUR/26264 | 930-10 | 8,9,11 | VBM500 | 930-46 | 14 | - | 930-97 | 5,9 |
| 15/00706 | 930-56 | 4,10 | LUR/26271 | 930-5 | 2,6,8,9,11,14 | VBM521 | 930-45 | 14 | - | 930-98 | 11 |
| 15/06804JD | 930-25 | 7 | LUR/26278 | 930-3 | 1,9 | XF117 | 930-31 | 3 | - | 930-104 | 9 |
| 15/30412 | 930-76 | 2,10 | LUR/27570 | 930-38 | 6,8,9,13 | XF130100 | 930-32 | 2,4,10,13 | - | 930-159 | 7,12,15 |
| 15/70436AR | 930-86 | 7,11 | M1618050 | 930-16 | 9 | Z86350913 | 930-51 | 15 | - | 930-160 | 5,7 |
| 69185771N | 930-75 | 15 | R3055414 | 930-22 | 1 | ZR976116 | 930-48 | 14,15 | - | 930-161 | 1,6 |
| 78350925 | 930-47 | 15 | R537140 | 930-140 | 2 | ZR6918 | 930-137 | 15 | - | 930-163 | 13 |
| FA4737758 | 930-35 | 4,8 | RR44450 | 930-58 | 7,11 | ZR83359918 | 930-49 | 15 | - | 930-164 | 4 |
| FA4737759 | 930-36 | 5,9 | RR47132 | 930-59 | 11 | - | 930-11 | 8,9 | - | 930-165 | 3 |
| FD11000 | 930-2 | 5 | RR519797 | 930-26 | 4,10 | - | 930-13 | 2 | - | 930-166 | 4 |
| FD8/11000AA | 930-9 | 6 | RR8543249 | 930-39 | 10 | - | 930-52 | 1 | - | 930-167 | 1 |
| FNN11000 | 930-8 | 5 | S9619/080 | 930-37 | 6,7,12 | - | 930-63 | 3 | - | 930-168 | 10 |
| K073 | 930-23 | 3,11 | S9619/180N | 930-126 | 6,8,12,13 | - | 930-80 | 2,6,8,9,11,14 | - | 930-169 | 13 |
| K073-24 | 930-30 | 3 | S9619/180NIS | 930-60 | 6,8,12,13 | - | 930-81 | 2,10 | - | 930-170 | 6 |
| K116/3758 | 930-29 | 3 | SF4737755 | 930-24 | 5,6,8 | - | 930-82 | 2,5,10 | - | 930-171 | 15 |
| K117/4166 | 930-68 | 3,11 | SF4807373 | 930-77 | 5 | - | 930-87 | 8,9 | - | | |

Part numbers are quoted for reference purposes only.
 Our parts and accessories are not original.



"THE RELIABLE SERVICE"



Las referencias originales tienen un propósito identificativo.
 Nuestras piezas no son originales.

STARTER MOTORS
MOTORES DE ARRANQUE



CROSS-REFERENCE - BOSCH - LISTA DE REFERENCIAS CRUZADAS

| Bosch Ref. Bosch Ref. | Old Ref. Ant. Ref. | Order N° Ref. No | Page Página | Bosch Ref. Bosch Ref. | Old Ref. Ant. Ref. | Order N° Ref. No | Page Página |
|--------------------------|-----------------------|---------------------|----------------|--------------------------|-----------------------|---------------------|----------------|
| 0001354090 | - | 930-92 | 2,6,7,12 | 0001367028 | - | 930-88 | 5,6,8 |
| 0001354091 | SLT2040 | 930-28 | 3,4,7,10 | 0001367029 | - | 930-97 | 5,9 |
| 0001358020 | - | 930-94 | 6,7,12 | 0001367032 | 15/00962V | 930-43 | 1,13,14,15 |
| 0001358046 | XF117 | 930-31 | 3 | 0001367034 | 15/30412 | 930-76 | 2,10 |
| 0001358049 | XF117 | 930-31 | 3 | 0001367039 | - | 930-169 | 13 |
| 0001358051 | - | 930-94 | 6,7,12 | 0001367040 | - | 930-80 | 2,6,8,9,11,14 |
| 0001359001 | - | 930-159 | 7,12,15 | 0001367042 | R537140 | 930-140 | 2 |
| 0001359004 | - | 930-94 | 6,7,12 | 0001367059 | 15/30412 | 930-76 | 2,10 |
| 0001359021 | - | 930-88 | 5,6,8 | 0001367067 | 15/00962V | 930-43 | 1,13,14,15 |
| 0001359025 | 15/00706 | 930-56 | 4,10 | 0001367072 | - | 930-52 | 1 |
| 0001359027 | K073 | 930-23 | 3,11 | 0001367075 | 15/70436AR | 930-86 | 7,11 |
| 0001359038 | S9619/180NIS | 930-60 | 6,8,12,13 | 0001367078 | 15/70436AR | 930-86 | 7,11 |
| 0001359043 | 15/30412 | 930-76 | 2,10 | 0001367300 | 15/30412 | 930-76 | 2,10 |
| 0001359047 | 15/00962V | 930-43 | 1,13,14,15 | 0001367301 | 15/30412 | 930-76 | 2,10 |
| 0001359048 | - | 930-159 | 7,12,15 | 0001368001 | K073-24 | 930-30 | 3 |
| 0001359053 | - | 930-159 | 7,12,15 | 0001368056 | - | 930-166 | 4 |
| 0001359073 | K073 | 930-23 | 3,11 | 0001369014 | - | 930-165 | 3 |
| 0001359083 | S9619/180NIS | 930-60 | 6,8,12,13 | 0001369015 | - | 930-161 | 1,6 |
| 0001359084 | 15/30412 | 930-76 | 2,10 | 0001369016 | 15/00704 | 930-54 | 1 |
| 0001359091 | UTB127 | 930-41 | 13 | 0001369017 | 15/00706 | 930-56 | 4,10 |
| 0001359099 | - | 930-159 | 7,12,15 | 0001369018 | 15/00705 | 930-55 | 1 |
| 0001359100 | - | 930-169 | 13 | 0001369019 | - | 930-52 | 1 |
| 0001359102 | - | 930-88 | 5,6,8 | 0001369022 | 15/70436AR | 930-86 | 7,11 |
| 0001359108 | - | 930-94 | 6,7,12 | 0001369023 | - | 930-161 | 1,6 |
| 0001359111 | - | 930-169 | 13 | 0001369025 | - | 930-52 | 1 |
| 0001359113 | S9619/180NIS | 930-60 | 6,8,12,13 | 0001369200 | - | 930-170 | 6 |
| 0001359122 | - | 930-97 | 5,9 | 0001369201 | - | 930-170 | 6 |
| 0001359124 | 15/00962V | 930-43 | 1,13,14,15 | 0001401068 | VBM500 | 930-46 | 14 |
| 0001360012 | K073-24 | 930-30 | 3 | 0001401074 | SF8962407 | 930-34 | 4 |
| 0001360035 | K073-24 | 930-30 | 3 | 0001413010 | VBM500 | 930-46 | 14 |
| 0001362016 | XF117 | 930-31 | 3 | 0001413016 | SF8962407 | 930-34 | 4 |
| 0001362017 | SLT2040 | 930-28 | 3,4,7,10 | 0986010990 | XF117 | 930-31 | 3 |
| 0001362018 | SLT2040 | 930-28 | 3,4,7,10 | 0986011020 | XF130100 | 930-32 | 2,4,10,13 |
| 0001362022 | - | 930-92 | 2,6,7,12 | 0986011021 | XF130100 | 930-32 | 2,4,10,13 |
| 0001362025 | XF130100 | 930-32 | 2,4,10,13 | 0986011140 | XF117 | 930-31 | 3 |
| 0001362032 | - | 930-91 | 5 | 0986011160 | - | 930-164 | 4 |
| 0001362034 | XF117 | 930-31 | 3 | 0986011161 | - | 930-164 | 4 |
| 0001362035 | - | 930-92 | 2,6,7,12 | 0986011180 | K116/3758 | 930-29 | 3 |
| 0001362039 | - | 930-91 | 5 | 0986011200 | K073 | 930-23 | 3,11 |
| 0001362040 | SLT2040 | 930-28 | 3,4,7,10 | 0986011220 | - | 930-88 | 5,6,8 |
| 0001362043 | XF130100 | 930-32 | 2,4,10,13 | 0986011221 | - | 930-88 | 5,6,8 |
| 0001362049 | - | 930-90 | 8,9,11 | 0986011240 | 15/30412 | 930-76 | 2,10 |
| 0001362051 | 15/30412 | 930-76 | 2,10 | 0986011250 | - | 930-169 | 13 |
| 0001362052 | - | 930-92 | 2,6,7,12 | 0986011270 | K073-24 | 930-30 | 3 |
| 0001362084 | - | 930-87 | 8,9 | 0986012670 | - | 930-91 | 5 |
| 0001362091 | XF117 | 930-31 | 3 | 0986012671 | - | 930-91 | 5 |
| 0001362305 | XF117 | 930-31 | 3 | 0986012710 | - | 930-94 | 6,7,12 |
| 0001362306 | XF130100 | 930-32 | 2,4,10,13 | 0986012720 | - | 930-97 | 5,9 |
| 0001362309 | 15/00671ST | 930-40 | 13 | 0986013480 | 15/30412 | 930-76 | 2,10 |
| 0001362311 | XF117 | 930-31 | 3 | 0986013680 | XF117 | 930-31 | 3 |
| 0001362313 | XF117 | 930-31 | 3 | 0986013690 | 15/00962V | 930-43 | 1,13,14,15 |
| 0001362314 | XF130100 | 930-32 | 2,4,10,13 | 0986013691 | 15/00962V | 930-43 | 1,13,14,15 |
| 0001362332 | - | 930-91 | 5 | 0986013720 | - | 930-166 | 4 |
| 0001363101 | - | 930-164 | 4 | 0986014740 | 15/70436AR | 930-86 | 7,11 |
| 0001363111 | - | 930-164 | 4 | 0986015040 | R537140 | 930-140 | 2 |
| 0001365004 | K116/3758 | 930-29 | 3 | 0986016550 | - | 930-165 | 3 |
| 0001366004 | SLT2040 | 930-28 | 3,4,7,10 | 0986017280 | 15/00704 | 930-54 | 1 |
| 0001367004 | K073 | 930-23 | 3,11 | 0986017290 | 15/00705 | 930-55 | 1 |
| 0001367005 | S9619/180NIS | 930-60 | 6,8,12,13 | 0986017310 | SLT2040 | 930-28 | 3,4,7,10 |
| 0001367009 | - | 930-159 | 7,12,15 | 0986017510 | - | 930-161 | 1,6 |
| 0001367010 | - | 930-169 | 13 | 0986018151 | LUR/27570 | 930-38 | 6,8,9,13 |
| 0001367011 | 15/00671ST | 930-40 | 13 | 9000083028 | 15/30412 | 930-76 | 2,10 |
| 0001367013 | - | 930-94 | 6,7,12 | 9000083054 | 15/30412 | 930-76 | 2,10 |
| 0001367014 | UTB127 | 930-41 | 13 | 9000143416 | - | 930-80 | 2,6,8,9,11,14 |

CROSS-REFERENCE - MAGNETI MARELLI - LISTA DE REFERENCIAS CRUZADAS

| Magneti Marelli Ref. Magneti Marelli Ref. | Old Ref. Ant. Ref. | Order N° Ref. No | Page Página | Magneti Marelli Ref. Magneti Marelli Ref. | Old Ref. Ant. Ref. | Order N° Ref. No | Page Página |
|--|-----------------------|---------------------|----------------|--|-----------------------|---------------------|----------------|
| MT 38 TB | SF4737755 | 930-24 | 5,6,8 | MT 68 T | K073 | 930-23 | 3,11 |
| MT 62 AA | SF8962407 | 930-34 | 4 | MT 71 A, AA, AB | SF4807373 | 930-77 | 5 |
| MT 68 A, AA, AB, AC, AD | SF4737755 | 930-24 | 5,6,8 | MT 71 FB | - | 930-92 | 2,6,7,12 |
| MT 68 L, LA, LB, LC | FA4737759 | 930-36 | 5,9 | MT 71 GB | SLT2040 | 930-28 | 3,4,7,10 |
| MT 68 PA | - | 930-94 | 6,7,12 | MT 71 Z | - | 930-163 | 13 |
| MT 68 R | S9619/180NIS | 930-60 | 6,8,12,13 | MT 72 A, AA, AB | - | 930-164 | 4 |
| MT 68 S | - | 930-80 | 2,6,8,9,11,14 | MT 74 G | XF117 | 930-31 | 3 |

Part numbers are quoted for reference purposes only.
Our parts and accessories are not original.

Las referencias originales tienen un propósito identificativo.
Nuestras piezas no son originales.



"THE RELIABLE SERVICE"





STARTER MOTORS
MOTORES DE ARRANQUE

CROSS-REFERENCE - LUCAS - LISTA DE REFERENCIAS CRUZADAS

| Lucas Ref. Lucas Ref. | Old Ref. Ant. Ref. | Order N° Ref. No | Page Página | Lucas Ref. Lucas Ref. | Old Ref. Ant. Ref. | Order N° Ref. No | Page Página |
|--------------------------|-----------------------|---------------------|----------------|--------------------------|-----------------------|---------------------|----------------|
| 25038 | LU25038 | 930-1 | 9 | 27528 | FD8/11000AA | 930-9 | 6 |
| 26031 | LUR/26278 | 930-3 | 1,9 | 27528 | - | 930-160 | 5,7 |
| 26072 | FD11000 | 930-2 | 5 | 27533 | M1608050 | 930-16 | 9 |
| 26132 | 15/00208IH | 930-7 | 2 | 27439 | LUR/26271 | 930-5 | 2,6,8,9,11,14 |
| 26133 | LUR/26278 | 930-3 | 1,9 | 27540 | LUR/26264 | 930-10 | 8,9,11 |
| 26137 | FNN11000 | 930-8 | 5 | 27540 | - | 930-87 | 8,9 |
| 26147 | FNN11000 | 930-8 | 5 | 27541 | LUR/26271 | 930-5 | 2,6,8,9,11,14 |
| 26154 | LU26206 | 930-4 | 8,9,11 | 27556 | R537140 | 930-140 | 2 |
| 26167 | LUR/26278 | 930-3 | 1,9 | 27565 | LUR/26271 | 930-5 | 2,6,8,9,11,14 |
| 26172 | FD11000 | 930-2 | 5 | 27568 | LUR/26271 | 930-5 | 2,6,8,9,11,14 |
| 26173 | LUR/26278 | 930-3 | 1,9 | 27569 | - | 930-160 | 5,7 |
| 26189 | FNN11000 | 930-8 | 5 | 27570 | LUR/27570 | 930-38 | 6,8,9,13 |
| 26193 | 15/00208IH | 930-7 | 2 | 27571 | LUR/26264 | 930-10 | 8,9,11 |
| 26200 | LU26206 | 930-4 | 8,9,11 | 27571 | - | 930-87 | 8,9 |
| 26211 | FD8/11000AA | 930-9 | 6 | 27572 | LUR/26271 | 930-5 | 2,6,8,9,11,14 |
| 26211 | - | 930-160 | 5,7 | 27572B | - | 930-80 | 2,6,8,9,11,14 |
| 26219 | LUR/26271 | 930-5 | 2,6,8,9,11,14 | 27575 | R537140 | 930-140 | 2 |
| 26220 | LU26206 | 930-4 | 8,9,11 | 27586 | R537140 | 930-140 | 2 |
| 26220 | - | 930-90 | 8,9,11 | 27588 | LUR/27570 | 930-38 | 6,8,9,13 |
| 26264 | LUR/26264 | 930-10 | 8,9,11 | LRS 115 | FD8/11000AA | 930-9 | 6 |
| 26271 | LUR/26271 | 930-5 | 2,6,8,9,11,14 | LRS 115 | - | 930-160 | 5,7 |
| 26273 | LUR/26264 | 930-10 | 8,9,11 | LRS 124 | LUR/27570 | 930-38 | 6,8,9,13 |
| 26274 | LUR/26271 | 930-5 | 2,6,8,9,11,14 | LRS 129 | - | 930-160 | 5,7 |
| 26278 | LUR/26278 | 930-3 | 1,9 | LRS 131 | LUR/26278 | 930-3 | 1,9 |
| 26284 | ZR6918 | 930-137 | 15 | LRS 134 | FD8/11000AA | 930-9 | 6 |
| 26284 | 15/00692V | 930-43 | 1,13,14,15 | LRS 134 | - | 930-160 | 5,7 |
| 26288 | 15/00208IH | 930-7 | 2 | LRS 137 | LUR/26271 | 930-5 | 2,6,8,9,11,14 |
| 26290 | SF4807373 | 930-77 | 5 | LRS 147 | LRS147 | 930-44 | 14 |
| 26290 | - | 930-91 | 5 | LRS 157 | LUR/26278 | 930-3 | 1,9 |
| 26291 | FD8/11000AA | 930-9 | 6 | LRS 161 | LUR/27570 | 930-38 | 6,8,9,13 |
| 26291 | - | 930-160 | 5,7 | LRS 162 | LUR/26271 | 930-5 | 2,6,8,9,11,14 |
| 26294 | LUR/27570 | 930-38 | 6,8,9,13 | LRS 166 | K957341 | 930-6 | 1 |
| 26295 | LUR/26271 | 930-5 | 2,6,8,9,11,14 | LRS 172 | 15/00208IH | 930-7 | 2 |
| 26323 | LUR/26271 | 930-5 | 2,6,8,9,11,14 | LRS 190 | LU26206 | 930-4 | 8,9,11 |
| 26336 | R537140 | 930-140 | 2 | LRS 195 | LUR/27570 | 930-38 | 6,8,9,13 |
| 26338 | FD8/11000AA | 930-9 | 6 | LRS 212 | FD8/11000AA | 930-9 | 6 |
| 26338 | - | 930-160 | 5,7 | LRS 212 | - | 930-160 | 5,7 |
| 26339 | - | 930-160 | 5,7 | LRS 215 | LUR/26271 | 930-5 | 2,6,8,9,11,14 |
| 26342 | ZR6918 | 930-137 | 15 | LRS 230 | FNN11000 | 930-8 | 5 |
| 26342 | 15/00692V | 930-43 | 1,13,14,15 | LRS 232 | LUR/26271 | 930-5 | 2,6,8,9,11,14 |
| 26344 | LUR/26264 | 930-10 | 8,9,11 | LRS 232 | - | 930-80 | 2,6,8,9,11,14 |
| 26344 | - | 930-87 | 8,9 | LRS 240 | R537140 | 930-140 | 2 |
| 26345 | LUR/26271 | 930-5 | 2,6,8,9,11,14 | LRS 301 | LUR/26264 | 930-10 | 8,9,11 |
| 26358 | LUR/26271 | 930-5 | 2,6,8,9,11,14 | LRS 301 | - | 930-87 | 8,9 |
| 26364 | FNN11000 | 930-8 | 5 | LRS 302 | LUR/27570 | 930-38 | 6,8,9,13 |
| 26365 | LUR/26264 | 930-10 | 8,9,11 | LRS 305 | LUR/26271 | 930-5 | 2,6,8,9,11,14 |
| 26365 | - | 930-87 | 8,9 | LRS 306 | LUR/26271 | 930-5 | 2,6,8,9,11,14 |
| 26366 | LUR/26271 | 930-5 | 2,6,8,9,11,14 | LRS 435 | 15/30412 | 930-76 | 2,10 |
| 26379 | FD8/11000AA | 930-9 | 6 | LRS 552 | FD8/11000AA | 930-9 | 6 |
| 26379 | - | 930-160 | 5,7 | LRS 552 | - | 930-160 | 5,7 |
| 26390 | SF4807373 | 930-77 | 5 | LRS 553 | M1618050 | 930-16 | 9 |
| 26390 | - | 930-91 | 5 | LRS 565 | 15/70436AR | 930-86 | 7,11 |
| 26395 | FD8/11000AA | 930-9 | 6 | LRS 568 | XF130100 | 930-32 | 2,4,10,13 |
| 26395 | - | 930-160 | 5,7 | LRS 570 | 15/00704 | 930-54 | 1 |
| 26398 | M1618050 | 930-16 | 9 | LRS 632 | XF130100 | 930-32 | 2,4,10,13 |
| 26410 | LUR/26271 | 930-5 | 2,6,8,9,11,14 | LRS 639 | XF130100 | 930-32 | 2,4,10,13 |
| 26410 | - | 930-80 | 2,6,8,9,11,14 | LRS 672 | K116/3758 | 930-29 | 3 |
| 26411 | LUR/26264 | 930-10 | 8,9,11 | LRS 765 | - | 930-166 | 4 |
| 26411 | - | 930-87 | 8,9 | LRS 839 | - | 930-164 | 4 |
| 26412 | LU26206 | 930-4 | 8,9,11 | LRS 847 | SF4737755 | 930-24 | 5,6,8 |
| 26412 | - | 930-90 | 8,9,11 | LRS 847 | - | 930-88 | 5,6,8 |
| 26413 | LUR/26271 | 930-5 | 2,6,8,9,11,14 | LRS 850 | SF4807373 | 930-77 | 5 |
| 26414 | LUR/26271 | 930-5 | 2,6,8,9,11,14 | LRS 850 | - | 930-91 | 5 |
| 26417 | 15/30412 | 930-76 | 2,10 | LRS 921 | XF117 | 930-31 | 3 |
| 27432 | - | 930-90 | 8,9,11 | LRS 921 | K073 | 930-23 | 3,11 |
| 26433 | R537140 | 930-140 | 2 | LRS 923 | K073-24 | 930-30 | 3 |
| 27409 | LU26206 | 930-4 | 8,9,11 | LRS 926 | ZR6918 | 930-137 | 15 |
| 27411 | LUR/26271 | 930-5 | 2,6,8,9,11,14 | LRS 926 | 15/00692V | 930-43 | 1,13,14,15 |
| 27413 | LUR/26278 | 930-3 | 1,9 | LRS 932 | SLT9619/110 | 930-125 | 6,7,12 |
| 27420 | 15/00208IH | 930-7 | 2 | LRS 932 | - | 930-94 | 6,7,12 |
| 27423 | LUR/26278 | 930-3 | 1,9 | LRS 940 | FA4737759 | 930-36 | 5,9 |
| 27432 | LU26206 | 930-4 | 8,9,11 | LRS 940 | - | 930-97 | 5,9 |
| 27433 | LUR/26271 | 930-5 | 2,6,8,9,11,14 | LRS 944 | UTB127 | 930-41 | 13 |
| 27463 | LUR/26278 | 930-3 | 1,9 | LRS 968 | LUR/27570 | 930-38 | 6,8,9,13 |
| 27470 | LU26206 | 930-4 | 8,9,11 | LRS 987 | - | 930-165 | 3 |
| 27470 | - | 930-90 | 8,9,11 | NSB 524 | LUR/27570 | 930-38 | 6,8,9,13 |
| 27500 | FD8/11000AA | 930-9 | 6 | NSB 526 | LUR/27570 | 930-38 | 6,8,9,13 |
| 27500 | - | 930-160 | 5,7 | NSB 531 | - | 930-80 | 2,6,8,9,11,14 |
| 27503 | LUR/26271 | 930-5 | 2,6,8,9,11,14 | NSB 540 | - | 930-80 | 2,6,8,9,11,14 |
| 27508 | R537140 | 930-140 | 2 | S 0850 | - | 930-91 | 5 |
| 27510 | LUR/26271 | 930-5 | 2,6,8,9,11,14 | S 4515 | LU26206 | 930-4 | 8,9,11 |
| 27515 | LUR/26271 | 930-5 | 2,6,8,9,11,14 | S 4515 | - | 930-90 | 8,9,11 |
| 27518 | LUR/27570 | 930-38 | 6,8,9,13 | S 4523 | LUR/26278 | 930-3 | 1,9 |
| 27519 | LUR/26271 | 930-5 | 2,6,8,9,11,14 | S 5012 | - | 930-160 | 5,7 |
| 27520 | LUR/27570 | 930-38 | 6,8,9,13 | S 5027 | LUR/26271 | 930-5 | 2,6,8,9,11,14 |
| 27522 | LUR/26264 | 930-10 | 8,9,11 | S 5027 | - | 930-80 | 2,6,8,9,11,14 |
| 27522 | - | 930-87 | 8,9 | S 5036 | LUR/26271 | 930-5 | 2,6,8,9,11,14 |
| 27523 | LUR/26271 | 930-5 | 2,6,8,9,11,14 | | | | |









Part numbers are quoted for reference purposes only.
Our parts and accessories are not original.



"THE RELIABLE SERVICE"













Las referencias originales tienen un propósito identificativo.
Nuestras piezas no son originales.

| Applications Aplicaciones | Ref. Ref. | OEM | A x B  | Z | L |
|--|--|---|--|-----|-----|
| Case IH | | | | | |
| 323, 353, 383, 423, 433, 440, 453, 533, 540, 633, 640, 733, 740, 833, 840, 940 | 62/930-206 12V / 2.7kW | 138207A1, 3218674R91, 3228192R91 | 3x127  | 11Z | 211 |
| 523, 553, 554, 624, 644, 654, 724, 743, 744, 745, 824, 844, 845, 856, 946, 955, 956, 1046, 1055, 1056, 1246, 1255, 1455 | 62/930-207 12V / 3.1kW | 3218677R91 3228193R91 121905A1 | 3x127  | 9Z | 186 |
| 1896, 2090, 2094, 2096, 2290, 2294, 2390, 2394, 2590, 2594, 3294, 3394, 3594, 4490, 4494, 4690, 4694, 7110, 7120, 7130, 7140, 7150, 7210, 7220, 7230, 7240, 7250, 8910, 8920, 8930, 8940, 8950, 9110, 9130, 9210, 9230, 9240, 9310, 9330 | ISKRA 62/930-201 12V / 4.2kW | 91902C2, A187728, A162469, A186271 | 3x146  | 10Z | 205 |
| 5120, 5220 | ISKRA 62/930-175 12V / 3.0kW | 1148001A1 | 3x127  | 10Z | 185 |
| 7210, 7220, 7230, 7240, 7250, 8910, 8920, 8930, 8940, 8950, 9310, 9330, MX180, MX200, MX210, MX220, MX230, MX240, MX255, MX270, MX285, STX275, STX325 | ISKRA 62/930-202 12V / 4.2kW | 193432A1, 193432A2, 87413500, 87413501, 87419387, 87420661 | 3x146  | 10Z | 250 |
| C50, C60, CX50, CX60 engine Perkins motor | ISKRA 62/930-181 12V / 3.0kW | 388186A1 | 3x127  | 10Z | 225 |
| C55, C64, C70, CS68, CS75, CS78, CS86, CS94 Engine MWM Motor | 62/930-208 12V / 2.7kW | 130100090735 | 3x127  | 9Z | 210 |
| C70, C80, C90, CX70, CX80, CX90, CX100, MX80C, MX90C, MX100C engine Perkins motor | 62/930-223 12V / 2.7kW ISKRA 62/930-200 12V / 3.0kW | 388187A1, 234987A1, 323319A1, 388187A2, 6106496M91 | 3x127  | 10Z | 204 |

Part numbers are quoted for reference purposes only.
Our parts and accessories are not original.

“THE RELIABLE SERVICE”

Las referencias originales tienen un propósito
identificativo. Nuestras piezas no son originales.

| Applications Aplicaciones | Ref. Ref. | OEM |  A x B |  Z |  L |
|---|--|--|--|---|---|
| Case IH | | | | | |
| CS68, CS75, CS78, CS86, CS94 engine Sisu motor (01/99 ->) | 62/930-209 12V / 2.7kW | 132000090705, 142000090700, 132000090740 | 3x127  | 11Z | 185 |
| CS100, CS110, CS120, CS130, CS150, CVX120, CVX130, CVX150, CVX170 | ISKRA 62/930-184 12V / 4.2kW | | | | |
| CVX1135, CVX1145, CVX1155, CVX1170, CVX1190 | ISKRA 62/930-184 12V / 4,2kW | 162000090722 | 3x127  | 11Z | 220 |
| JX1070U, JX1080U, JX1090U, JX1100U | ISKRA 62/930-203 12V / 4.2kW | 47132888, 47137534, 47137538 | 3x127  | 10Z | 222 |
| MXM120, MXM130, MXM135, MXM140, MXM150, MXM155, MXM165, MXM175, MXM180, MXM190 | 62/930-222 12V / 2.7kW | 82021372 | 3x146  | 10Z | 230 |
| | ISKRA 62/930-173 12V / 3.0kW | | | | |
| MXU100, MXU110, MXU115, MXU125, MXU135 | ISKRA 62/930-191 12V / 3.0kW | 82032859, 4897223 | 3x127  | 10Z | 245 |
| Claas | | | | | |
| Consul, Dominator, Jaguar, Mercator Engine Mercedes Motor | 62/930-210 12V / 2.7kW | 6853810 | 3x127  | 9Z | 238 |
| David Brown | | | | | |
| 1594, 1690, 1694 | 62/930-222 12V / 2.7kW | K308650 | 3x146  | 10Z | 230 |
| | ISKRA 62/930-173 12V / 3.0kW | | | | |

Part numbers are quoted for reference purposes only.
Our parts and accessories are not original.

"THE RELIABLE SERVICE"

Las referencias originales tienen un propósito
identificativo. Nuestras piezas no son originales.









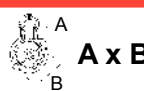

Starter motors with reducer
Motores de arranque con reductor

Deutz

Fendt

Fermec

bepco tractor parts

| Applications <i>Aplicaciones</i> | Ref. <i>Ref.</i> | OEM | A x B  | Z  |  |
|--|--|--|--|--|---|
| Deutz | | | | | |
| Civil motorering / <i>Obras públicas</i> | ISKRA 62/930-211 24V / 4.0kW | 01164995 01173241 01180999 | 3x127  | 9Z | 237 |
| Engines / <i>Motors</i> FL912, FL913, BF1012, BF1013 3, 4 et 5 cylinders / <i>3, 4 & 5 cilindros</i> | 62/930-221 12V / 2.7kW ISKRA 62/930-193 12V / 3.0kW | 01174166, 01164668 01170051, 01175886 01179586, 01161384 01163669, 01164994 01173240, 01179318 01180805 | 3x127  | 9Z | 204 |
| F2L1011, F3L1011, F4L1011, BF4L1011 | ISKRA 62/930-185 12V / 2.8kW | 01180180 01180995 | 3x127  | 10Z | 220 |
| Fendt | | | | | |
| Engines / <i>Motors</i> FL912, FL913, BF1012, BF1013 3, 4 et 5 cylinders / <i>3, 4 & 5 cilindros</i> Farmer 307, 308, 409, 410, 411 Favorit 711, 712, 714, 716 | 62/930-221 12V / 2.7kW ISKRA 62/930-193 12V / 3.0kW | X830.100.001.000 6380.900.060.010 X830.100.007.000 F716.900.060.060 | 3x127  | 9Z | 204 |
| Engine MAN <i>Motor</i> Serie 800 et 900 / <i>800 and 900 serie</i> Xylon 520, 522, 524 | ISKRA 62/930-196 24V / 4.0kW | F524.900.060.010 F926.900.060.040 F926.900.060.041 F824.900.060.130 | 3x127  | 11Z | 240 |
| Engines MWM D226 <i>Motors</i> 3 cylinders / <i>3 cilindros</i> Farmer 103, 104 Farmer 303, 304, 307 | 62/930-208 12V / 2.7kW | F135.902.060.010, X830.100.009.000 | 3x127  | 9Z | 210 |
| Engines MWM D226, D227 <i>Motors</i> 4 et 6 cylinders / <i>4 and 6 cilindros</i> Farmer series 100, 200, 300 <i>series</i> Favorit series 500, 600 <i>series</i> | 62/930-177 12V / 2.7kW | G514.900.060.100 F135.902.060.010 X830.100.006.000 | 3x127  | 9Z | 212 |
| Fermec | | | | | |
| 640B, 650B, 660B, 750, 760, 860, 960, 965 | ISKRA 62/930-180 12V / 3.0kW | | 3x127  | 10Z | 244 |

Part numbers are quoted for reference purposes only.
Our parts and accessories are not original.

"THE RELIABLE SERVICE"

Las referencias originales tienen un propósito
identificativo. Nuestras piezas no son originales.

bepco tractor parts







Fiat

Ford

JCB

John Deere

Starter motors with reducer
Motores de arranque con reductor

| Applications Aplicaciones | Ref. Ref. | OEM | A x B  |
|---|--|--|---|
| Fiat | | | |
| 800, 805, 880/4, 1300S Engine OM Motor | 62/930-212 12V / 2.7kW | 4712894 4713805 4737758 | 3x127  9Z 190 |
| Ford | | | |
| 2000, 2310, 2600, 2610, 3000, 3600, 3610, 2810, 2910, 3230, 3430, 3900, 3910, 3430, 4000, 4100, 4110, 4130, 4600, 4610, 4630, 4830, 5000, 5030, 5110, 5600, 5610, 5610S, 5640, 5700, 5900, 6410, 6600, 6610, 6610S, 6640, 6700, 6710, 6810, 6810S, 7000, 7010, 7410, 7600, 7610, 7610S, 7740, 7700, 7710, 7810, 7810S, 7840, 7910, 8000, 8010, 8160, 8200, 8210, 8240, 8260, 8340, 8360, 8530, 8560, 8600, 8630, 8700, 8730, 8830, 9000, 9200, 9600, 9700, TS80, TS90, TS100, TS110, TS115, TW5, TW10, TW15, TW20, TW25, TW30, TW35 | 62/930-222 12V / 2.7kW ISKRA 62/930-173 12V / 3.0kW | D8NN11000CE 83981923 82005342 82007917 82013922 E3NN11000AA 83943890 | 3x146  10Z 230 |
| JCB | | | |
| 110, 413, 418, 702, 704, 805, 805B, 806, 806B, 807, 807B, 808, 902, 1250, SL702P, SL704P, SL900P, SL1000P, SL1500P, SL1750P | 62/930-223 12V / 2.7kW ISKRA 62/930-200 12V / 3.0kW | | 3x127  10Z 204 |
| 3CX4, 4CX, 420, 430, 807C, 811, 812, 814, 817, 818, 820, Fastrac 125, 135, 145, 155, 185, 1115, 1135 | 62/930-213 12V / 2.7kW | 71429300R 71429500R | 3x127  10Z 199 |
| 805 (1/76 ->) 806, 806B, 807B (-> 1/82) | 62/930-222 12V / 2.7kW ISKRA 62/930-173 12V / 3.0kW | | 3x146  10Z 230 |
| John Deere | | | |
| 5210, 5310, 5410 John Deere USA Engine PowerTech Motor | ISKRA 62/930-179 12V / 2.8kW | RE19275 RE54092 RE51447 RE68470 | 2x105  10Z 235 |
| 5310, 5410, 5510, 5310N, 5410N, 5510N Engine PowerTech Motor | ISKRA 62/930-215 12V / 2.8kW | RE516455 RE60641 RE63010 | 2x105  10Z - |

Part numbers are quoted for reference purposes only.
Our parts and accessories are not original.

"THE RELIABLE SERVICE"

Las referencias originales tienen un propósito
identificativo. Nuestras piezas no son originales.

Ed. 1 (08/06)

Dém. -5











Starter motors with reducer
Motores de arranque con reductor

John Deere

Landini

Laverda

bepco tractor parts

| Applications <i>Aplicaciones</i> | Ref. <i>Ref.</i> | OEM |  A x B |  Z |  L |
|---|--|---|--|--|--|
| John Deere | | | | | |
| 5510, 6520, 6810, 6820, 6920 | ISKRA 62/930-224 12V / 4.2kW | RE503226 |  | 10Z | - |
| 6500, 6600, 6800, 6900, 6510, 6610, 6810, 6910 | ISKRA 62/930-189 12V / 4.2kW | AL70852 AL81154 RE505744 RE507639 | 3x127  | 10Z | 220 |
| Engine / Motor 4045D, 4045T, 6068D, 6068T, 6059D, 6059T, 2.9L PT, 4.5L PT, 6.8L PT Telescopic / Telescópicas 4400, 4500, Combines / Cosechadoras 1170 | ISKRA 62/930-198 12V / 4.2kW | RE503093, RE504009, RE59010, RT7700040288, R116617, RE68783 | 3x127  | 10Z | 226 |
| Engine / Motor 3029, 4039, 4045D, 4239D, 4239T, 4276, 6059, 6068, 6329D, 6359D, 6359T, 2.9L PT, 4.5L PT | ISKRA 62/930-197 24V / 4.0kW | RE51725, RE52120, RE19737, RE49352 | 2x105  | 10Z | 240 |
| Series 10, 20, 30, 40, 50 Series, 6010, 6110, 6210, 6310, 6410, 6100, 6200, 6300, 6400 Sans/Without powertech | 62/930-178 12V / 2.7kW ISKRA 62/930-225 12V / 3.0kW | AL11503, AL41247 AL62691, AL62773 AL78760, AL110503 AL110504, AR70436, AR70437, AT23401, RE60384, RE500733 | 2x105  | 10Z | 195 |
| Landini | | | | | |
| Engines Perkins Motors A4-212, A4-236, A4-248, A6-354 | 62/930-223 12V / 2.7kW ISKRA 62/930-200 12V / 3.0kW | 3542185M91 3546391M91 | 3x127  | 10Z | 204 |
| Engines Perkins Motors A4-203, AD4-203 | 62/930-218 12V / 2.7kW | 3597371M2 | 3x146  | 10Z | 205 |
| Engine Perkins Motor Serie 1000 Serie | 62/930-213 12V / 2.7kW | 3551773M91 3648190M91 | 3x127  | 10Z | 199 |
| Laverda | | | | | |
| M152 Engine OM Motor | 62/930-212 12V / 2.7kW | 4712894 4713805 4737758 | 3x127  | 9Z | 190 |

Part numbers are quoted for reference purposes only.
Our parts and accessories are not original.

"THE RELIABLE SERVICE"









Las referencias originales tienen un propósito
identificativo. Nuestras piezas no son originales.

bepco tractor parts

Manitou

Massey Ferguson

Starter motors with reducer
Motores de arranque con reductor

| Applications Aplicaciones | Ref. Ref. | OEM | A x B  | Z | L |
|--|---|--|--|-----|-----|
| Manitou | | | | | |
| Perkins | 62/930-213 12V / 2.7kW | 2873B056, 2873B071 | 3x127  | 10Z | 199 |
| | 62/930-223 12V / 2.7kW ISKRA 62/930-200 12V / 3.0kW | 2873B072 | 3x127  | 10Z | 204 |
| Massey Ferguson | | | | | |
| Engines Perkins Motors A3-152, AD3-152, A4-192, A4-203, AD4-203 65, 133, 134, 135, 140, 145, 148, 152, 154, 155, 158, 165/II, 230, 233, 234, 235, 240, 245, 250, 253, 254, 255, 260, 263, 264, 350, 353, 355, 360 363, 364, 550, 560 | 62/930-218 12V / 2.7kW | 1680065M3 1868283M5 3597371M1 3597426M3 3763363M91 | 3x146  | 10Z | 205 |
| Engines Perkins Motors A4-212, A4-236, A4-248, A4-318, A6-354 165/III, 168, 174, 175, 178, 184, 185, 188, 194, 265, 273, 274, 275, 283, 284, 285, 290, 293, 294, 298, 362, 365, 373, 374, 375, 377, 383, 384, 387, 390, 393, 394, 397, 398, 399, 565, 575, 590, 592, 595, 675, 690, 698, 699, 1004, 1014, 1080, 1114, 3050, 3060, 3065, 3070, 3075, 4225, 4235, 4240, 4245, 4255, 4260, 4270, 6110, 6120, 6130, 6140, 6150 | 62/930-223 12V / 2.7kW ISKRA 62/930-200 12V / 3.0kW | 1860093M2 1868285M3 2873006M1 1447301M91 3597372M1 1447731M1 3763362M91 1680064M1 | 3x127  | 10Z | 204 |
| 3085, 3095, 3115, 3125, 3635, 3645, 3655, 3670, 3680, 3690, 6160, 6170, 6180, 6190, 6410, 6510, 6710, 6810, 6260, 6270, 6280, 6290, 8110, 8120, 8130, 8140, 8150, 8160, 8210, 8220, 8240, 8250 | 62/930-213 12V / 2.7kW | 3581576M2 1447732M1 | 3x127  | 10Z | 199 |
| 6260, 6270, 6280, 6290, 8210, 8220 | ISKRA 62/930-181 12V / 4.2kW | 3581576M3 3784890M1 3823621M91 | 3x127  | 10Z | 225 |
| Engines Perkins Motors 1004, 1006 4225, 4235, 4240, 4245, 4255, 4265, 4325, 4335, 4345, 4355, 4365, 6235, 6245, 6255, 6265 | ISKRA 62/930-180 12V / 3.0kW | 3821818M91 | 3x127  | 10Z | 244 |

Part numbers are quoted for reference purposes only.
Our parts and accessories are not original.

"THE RELIABLE SERVICE"

Las referencias originales tienen un propósito
identificativo. Nuestras piezas no son originales.

Ed. 1 (08/06)

Dém. -7

Starter motors with reducer
Motores de arranque con reductor









Mc Cormick

Minsk Tractors

New Holland

MB Track

bepco tractor parts

| Applications <i>Aplicaciones</i> | Ref. <i>Ref.</i> | OEM |  |
|---|--|--|--|
| MB Track | | | |
| 700, 800, 900, 1000, 1100, 1300, 1400, 1500, 1600 | 62/930-210 12V / 2.7kW | 0031510501 0031517301 0031518701 0041512201 | 3x127  9Z 238 |
| Mc Cormick | | | |
| CX70, CX80, CX90, CX100, MC80, MC90, MC100, MC115 F80, F90, F100 MTX110, MTX155, MTX175 T70, T80, T100 | 62/930-223 12V / 2.7kW ISKRA 62/930-200 12V / 3.0kW | 706022A1 | 3x127  10Z 204 |
| CX50, CX60 | ISKRA 62/930-181 12V / 3.0kW | 388186A1 | 3x127  10Z 225 |
| Minsk tractors Belarus | | | |
| MTZ 80, 82, 510, 512, 520, 522, 530, 532, 550, 552, 570, 572, 590, 592, 800, 820, 900, 920, 922, 950, 952, 1005, 1025 | 62/930-219 12V / 2.7kW On demand Sobre pedido | 24073708000 | 3x127  10Z 208 |
| New Holland | | | |
| TL70A, TL80A, TL90A, TL100A TN85A, TN85DA, TN85SA, TN95A, TN95DA | 62/930-203 ISKRA 12V / 4.2kW | 47132888 47137534 47137538 | 3x127  10Z 222 |
| TM115, TM120, TM125, TM130, TM135, TM140, TM150, TM155, TM165, TM175, TM190 TS80, TS90, TS100, TS110, TS115 | 62/930-222 12V / 2.7kW ISKRA 62/930-173 12V / 3.0kW | 82021372 | 3x146  10Z 215 |
| TS100A, TS110A, TS115A, TS125A, TS135A | ISKRA 62/930-191 12V / 3.0kW | 82032859 82039052 | 3x127  10Z 245 |

Part numbers are quoted for reference purposes only.
Our parts and accessories are not original.











"THE RELIABLE SERVICE"

Las referencias originales tienen un propósito
identificativo. Nuestras piezas no son originales.

bepco tractor parts

Renault

Starter motors with reducer
Motores de arranque con reductor

| Applications <i>Aplicaciones</i> | Ref. <i>Ref.</i> | OEM |  A x B |  Z |  L |
|---|--|--|--|---|---|
| Renault Engines / Motors MWM D226, 227, 325, 327 50, 51, 53, 56, 60, 70, 80, 82, 86, 89, 90, 91, 92, 94, 96, 98, 301, 351, 361, 421, 456, 460, 461, 462, 480, 486, 489, 490, 496, 498, 551, 556, 651, 652, 656, 681, 781, 851, 891, 951, 981, 58-12, 58-14, 58-32, 58-34, 61-12, 61-14, 65-12, 65-14, 65-32, 65-34, 68-12, 68-14, 70-12, 70-14, 70-32, 70-34, 75-12, 75-14, 80-12, 80-14, 85-12, 85-14, 85-32, 85-34, 90-32, 90-34, 95-12, 95-14, 103-12, 103-14, 110-14, 113-12, 113-14, 120-14, 120-54, 133-14, 133-54, 145-14, 145-54 551-4, 651-4, 751-4, 1151-4, 1181-4 | 62/930-177 12V / 2.7kW | 6005003152 6005003153 6005011729 6005701125 7700026780 7700501670 7700519797 7700525064 7700525547 7700627394 | 3x127  | 9Z | 212 |
| Engine DPSG Motor Ares 540, 550, 610, 620, 630, 640 | ISKRA 62/930-189 12V / 4.2kW | 7700044450 7700045291 | 3x127  | 10Z | 220 |
| Engine DPSG Motor Ceres 310, 320, 330, 340, Cergos 330, 340, 350, Ergos 85, 95, 105 | 62/930-178 12V / 2.7kW ISKRA 62/930-225 12V / 3.0kW | 6005012976 6005022635 | 2x105  | 10Z | 195 |
| Engine DPSG Motor Ares 710, 720, 725, 735, 815, 825, Temis 550 | ISKRA 62/930-182 12V / 3.0kW | 7700047132 | 2x105  | 10Z | 230 |
| Engines / Motors MWM D226, 3 cylinders / 3 cilindros | 62/930-208 12V / 2.7kW | 7700046893 7700627394 7700026780 6005011729 7700501670 | 3x127  | 9Z | 210 |
| Engines Deutz Motors FL912, FL913 | 62/930-221 12V / 2.7kW ISKRA 62/930-193 12V / 3.0kW | 6005016395 6000103270 6000102270 | 3x127  | 10Z | 204 |
| Engines Perkins Motors 4-236, 4-248 | 62/930-223 12V / 2.7kW ISKRA 62/930-200 12V / 3.0kW | 7701031686 6005700081 6005003154 | 3x127  | 10Z | 204 |

Part numbers are quoted for reference purposes only.
Our parts and accessories are not original.

"THE RELIABLE SERVICE"

Las referencias originales tienen un propósito
identificativo. Nuestras piezas no son originales.

Ed. 1 (08/06)

Dém. -9

Starter motors with reducer
Motores de arranque con reductor









Steyr

Valmet

Volvo

Zetor

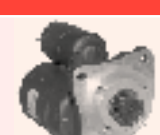
bepco tractor parts

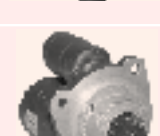
| Applications Aplicaciones | Ref. Ref. | OEM | A x B  | |
|---|--|------------------------------|--|------------|
| Steyr | | | | |
| 950, 960, 8055, 8060, 8070, 8075, 8080, 8090 | 62/930-220 12V / 2.7kW | | 2x105  | 9Z 210 |
| 955, 964, 970, 9078, 9083, 9086, 9094 M968, M975, M9078, M9083, M9086, M9094 Engine MWM Motor | 62/930-208 12V / 2.7kW | 130100090735 | 3x127  | 9Z 210 |
| 4100 Profi, 4115 Profi, 6115 Profi, 6125 Profi, 6135 Profi | ISKRA 62/930-191 12V / 3.0kW | 82032859 4897223 | 3x127  | 10Z 245 |
| 6135CVT, 6145CVT, 6155CVT, 6170CVT, 6190CVT | ISKRA 62/930-184 12V / 4.2kW | 162000090722 | 3x127  | 11Z 220 |
| 9105, 9115, 9125, 9145 Engine Valmet Motor CVT120, CVT150, CVT170 | 62/930-209 12V / 2.7kW ISKRA 62/930-184 12V / 4.2kW | 132000090705 142000090700 | 3x127  | 11Z 185 |
| Valmet | | | | |
| 305, 405, 455, 502, 504, 505, 602, 604, 605, 655, 700, 702, 703, 705, 712, 755, 802, 803, 805, 855, 900, 902, 903, 905, 1100, 1102, 1112, 1203, 6000 | 62/930-209 12V / 2.7kW ISKRA 62/930-184 12V / 4.2kW | 835331592 | 3x127  | 11Z 185 |
| Volvo | | | | |
| Engine Perkins Motor BM 500, BM 2200, 2204, 2250, 2254 | 62/930-223 12V / 2.7kW ISKRA 62/930-200 12V / 3.0kW | | 3x127  | 10Z 204 |
| Zetor | | | | |
| 3011, 3045, 3320, 3340, 3511, 3513, 3545, 4320, 4321, 4340, 4341, 4511, 4611, 4712, 4718, 4911, 5011, 5211, 5245, 5320, 5321, 5340, 5341, 5511, 5545, 5516, 5611, 5645, 5647, 5711, 5718, 5745, 5748, 5911, 5945, 6011, 6045, 6211, 6212, 6245, 6320, 6321, 6340, 6341, 6511, 6518, 6522, 6711, 6718, 6745, 6748, 6911, 6918, 6945, 7011, 7045, 7211, 7245, 7320, 7321, 7340, 7341, 7711, 7745 | 62/930-209 12V / 2.7kW ISKRA 62/930-184 12V / 4.2kW | 69185771 | 3x127  | 11Z 185 |
| 8011, 8045, 8111, 8145, 8211, 8245, 9211, 9245, 10011, 10045, 10111, 10145, 10211, 10245 | 62/930-48 12V / 2.7kW | 9142742 | 3x127  | 11Z 186 |

Part numbers are quoted for reference purposes only.
Our parts and accessories are not original.

"THE RELIABLE SERVICE"

Las referencias originales tienen un propósito
identificativo. Nuestras piezas no son originales.

Dém. -10

Ed. 1 (08/06)

| Ref. Trac. <i>Trac.ref.</i> | Ref. Iskra <i>Iskra ref.</i> | Ref. Trac. <i>Trac.ref.</i> | Ref. Iskra <i>Iskra ref.</i> | Ref. Magneton <i>Magneton ref.</i> |
|---|--|---|--|--|
| Démarrateurs std <i>Std starter</i> | | Dém. avec réducteur "ISKRA" <i>Starter with reducer "ISKRA"</i> | | |
| 930-30 | IS0491 | 930-211 | IS0842 | |
| 930-31 | IS0551 | 930-193 | IS0841 | 930-221 |
| 930-23 | IS0552 | 930-193 | IS0841 | 930-221 |
| 930-205 | IS0565 | 930-185 | IS1072 | |
| 930-165 | IS0567 | 930-193 | IS0841 | 930-221 |
| 930-86 | IS0569 | 930-225 | IS0793 | 930-178 |
| 930-160 | IS0579 | 930-173 | IS1016 | 930-222 |
| 930-161 | IS0627 | 930-173 | IS1016 | 930-222 |
| 930-166 | IS0626 | 930-196 | IS0730 | |
| 930-175 | IS0665 | 930-175 | IS1090 | |
| 930-58 | IS0739 | 930-189 | IS0794 | |
| 930-59 | IS0820 | 930-182 | IS1055 | |
| 930-43 | IS0179 | 930-184 | IS0836 | 930-209 |
| 930-76 | IS0412 | | | 930-210 |
| 930-168 | IS0436 | | | 930-219 |
| 930-55 | IS0705 | | | 930-206 |
| 930-54 | IS0704 | | | 930-207 |
| 930-56 | IS0706 | | | 930-177 |
| 930-80 | IS0872 | 930-200 | IS1098 | 930-223 |
| 930-35 | IS0862 | | | 930-212 |
| 930-87 | IS0632 | | | 930-218 |
| 930-38 | IS0526 | | | 930-213 |
| 930-80 | IS0509 | 930-200 | IS1098 | 930-223 |
| 930-32 | IS0669 | | | 930-208 |
| 930-40 | IS0671 | | | 930-220 |
| 930-194 | IS0709 | | | 930-220 |
| 930-82 | IS0807 | 930-180 | IS1023 | |
| 930-81 | IS0808 | 930-181 | IS1071 | |
| | | 930-198 | IS1056 | |
| | | 930-197 | IS1088 | |
| | | 930-201 | IS1089 | |
| | | 930-202 | IS1077 | |
| | | 930-191 | IS0999 | |
| | | 930-203 | IS1109 | |
| | | 930-182 | IS1055 | |
| | | 930-179 | IS1027 | |
| | | 930-215 | IS1059 | |
| | | 930-217 | IS1087 | |
| | | 930-224 | IS1157 | |

Part numbers are quoted for reference purposes only.
 Our parts and accessories are not original.

"THE RELIABLE SERVICE"

Las referencias originales tienen un propósito
 identificativo. Nuestras piezas no son originales.

**BEPCO PARTS SA****HERMALLE-SOUS-HUY**

Rue Chaumont, 4D • 4480 Hermalle-sous-Huy • Belgique
T +32 85 24 54 00 • F +32 85 24 54 50
info.be@becoparts.com • www.becoparts.com

VILLERS-LE-BOUILLET

Rue de Waremme, 114 • 4530 Villers-le-Bouillet • Belgique
T +32 85 24 54 00 • F +32 85 24 54 50
info.be@becoparts.com • www.becoparts.com

**BEPCO UK LTD**

Bepco House • Unit 316 • Hartlebury Trading Estate
Hartlebury - Worcestershire, DY10 4JB (UK)
P +44 (0)1299 252270 • F 0800 216553
info@becoparts.com • www.becoparts.com

**BEPCO FRANCE SAS**

Z.I. La Plaine, Allée de Bigorre
BP80041 Le Passage • 47901 Agen Cedex 9 • France
T +33 (0)553 96 31 25 • F +33 (0)553 68 03 72
info.fr@becoparts.com • www.becoparts.com

VILLENEUVE-SUR-LOT

294 Av. de Bordeaux • CS 30059 Bias
FR-47302 Villeneuve sur lot • France
T +33 (0)5 53 40 37 50 • F +33 (0)5 53 70 61 93

JANZÉ

P.A. de la Chauvelière • Rue Charles Lindbergh
35150 JANZE • France
T + 33 (0)2 99 44 16 18 • F +33 (0)2 99 44 17 29

**TVH AUSTRALASIA PTY LTD**

HEAD OFFICE BRISBANE • www.becoparts.com

ADELAIDE

96 South Terrace • Wingfield SA 5013
Free 1800 182 344 • T +61 8 8359 8933 • F +61 8 8234 2212
BepcoSAsales@tvh.com.au

BRISBANE

735 Boundary Road • Richlands QLD 4077
Free 1800 020 082 • T +61 7 3344 1113 • F +61 7 3344 1332
BepcoQLDsales@tvh.com.au

MELBOURNE

7/66-74 Micro Circuit • Dandenong South VIC 3175
Free 1800 802 367 • T +61 3 9796 5422 • F +61 3 9796 5251
BepcoVICsales@tvh.com.au

PERTH

2/15 Colin Jamieson Drive • Welshpool WA 6106
Free 1800 182 344 • T +61 8 8352 8984 • F +61 8 8234 2212
BepcoWAsales@tvh.com.au

SYDNEY

1/1002-1010 Canley Vale Rd • Wetherill Park NSW 2164
Free 1800 808 827 • T +61 2 6885 5288 • F +61 3 9796 5251
BepcoNSWsales@tvh.com.au

**TVH NEW ZEALAND LTD****AUCKLAND**

PO Box 51490 • Pakuranga 2140 • 11K Echelon Place
East Tamaki • Auckland
Free 0800 459 662 • T +64 9 274 9695 • F +64 9 274 9698
info@tvh.co.nz • www.tvh.com

CHRISTCHURCH

11C Parkhouse Road
Wigram • Christchurch 8042
Free 0508 8 722 867 • T +64 3 550 1298 • F +64 3 974 9993
infochch@tvh.co.nz

**BEPCO DEUTSCHLAND GmbH**

Neuer Weg 5 • 59505 Bad Sassendorf • Germany
T +49 (0)2927 919 59 0 • F +49 (0)2927 919 59 59
info.de@becoparts.com • www.becoparts.com

**BEPCO NEDERLAND BV**

Den Dolvert 10 • 5473 GP, Heeswijk-Dinther • Nederland
T +31 (0)413 29 39 75 • F +31 (0)413 29 40 87
info.nl@becoparts.com • www.becoparts.com

**BEPCO IBÉRICA SA**

C/ Torrent de Vallmajor, 82
08915 Badalona (Barcelona) • Spain
T +34 (0)902 111 062 - 933 810 062 • F +34 (0)933 813 345
info.es@becoparts.com • www.becoparts.com

ALMENDRALEJO

Ctra. Badajoz - Pol. «Rayvaz» Nave 21
06200 Almendralejo (Badajoz)
T +34 (0)902 111 062 - 924 664 890
F +34 (0)924 664 576

DOS HERMANAS

Pol. Ind. La Isla, C/ Hornos, 11
41703 Dos Hermanas (Sevilla)
T +34 (0)902 111 062 - 954 931 546
F +34 (0)954 930 130

SANTIAGO DE COMPOSTELA

Pol. El Tambre, Via Faraday, 36
15890 Santiago de Compostela
T +34 (0)902 111 062 - 981 560 012
F +34 (0)981 557 753

**TVH PARTS SOUTH AFRICA (Pty) Ltd**

HEAD OFFICE JOHANNESBURG • www.tvh.com

CAPE TOWN

1 Karee Street • Kraaifontein Industries • Cape Town 7571
T +27 21 988 2432 • F +27 21 988 9127
capetownsales@tvh.com

DURBAN

2 Monaco Place • Westmead • Pinetown 3600
T +27 31 100 0760 • F +27 31 700 6191
durbansales@tvh.com

JOHANNESBURG

90 Electron Avenue • Isando • Kempton Park 1601
T +27 11 281 27 00 • F +011 974 9845
johannesburgsales@tvh.com

LICHTENBURG

Shop 1 • 109 Scholtz Street • Lichtenburg 2740
T +27 18 632 6192/6092 • F +27 18 632 6108
lichtenburgsales@tvh.com

PORT ELIZABETH

134 Kempston Road • Korsten • Port Elizabeth 6020
T +27 41 453 1404/8 • F +27 41 453 1409
portelizabethsales@tvh.com

FOR ALL OUR LATEST CATALOGUE UPDATES AND COMPANY INFO: WWW.BEPCOPARTS.COM



The spare parts mentioned in this list can normally be delivered from stock. In addition, we can supply parts, which are not mentioned in this catalogue, with the shortest possible delivery time. The O.E.M. references are only for indication purposes and do not imply that the spare parts are coming from the manufacturer. This spare parts list can be modified without prior notice. All photographs, drawings, illustrations, brand names, descriptions and numbers are included for identification purposes only.



De onderdelen vermeld in deze lijst, zijn normaal uit voorraad leverbaar, behoudens uitverkocht. Ook niet-vermelde onderdelen kunnen binnen de kortste tijd uitgeleverd worden. De O.E.M. referenties dienen enkel ter indicatie en impliceren niet dat deze van de vermelde constructeur afkomstig zijn. Deze onderdelenlijst kan zonder enige voorafgaande verwittiging aangepast worden. Alle gebruikte foto's, tekeningen, afbeeldingen, merknamen, omschrijvingen en nummers dienen alleen ter identificatie.



Les pièces de rechange, mentionnées dans cette liste, sont normalement livrables du stock. En plus, les articles non indiqués peuvent être fournis en peu de temps. Cette liste peut être modifiée sans avis préalable. Les références O.E.M. sont seulement indicatives et n'impliquent pas que les pièces de rechange viennent du constructeur. Toutes les photographies, illustrations, marques, descriptions, tous les plans et numéros servent exclusivement à une identification.



Die in dieser Liste aufgeführten Teile sind normalerweise aus dem Lager lieferbar. Wir sind zudem in der Lage nicht aufgeführte Teile innerhalb kürzester Zeit zu liefern. Die O.E.M. Referenznummern dienen zur Information und beinhalten nicht, dass diese vom genannten Hersteller kommen. Diese Bestandsliste kann ohne vorhergehende Ankündigung geändert werden. Alle verwendeten Foto's, Zeichnungen, Abbildungen, Markennamen, Beschreibungen und Nummern dienen nur zu Identifikationszwecken.



Los artículos mencionados en este catálogo se encuentran habitualmente en stock. Además, podemos suministrar en un plazo corto de tiempo otros artículos relacionados que no se encuentren expresamente mencionados en este catálogo. Las referencias O.E.M. sirven sólo como indicación y no implican que procedan del constructor. Este listado de productos puede estar sujeto a modificaciones sin aviso previo. Todas las fotos, dibujos, ilustraciones, nombres de marca, descripciones y números se han incluido simplemente con el propósito de su identificación.



I pezzi di ricambio, menzionati in questo listino, possono essere forniti con una consegna immediata a condizione che non siano esauriti. I pezzi di ricambio non menzionati possono essere forniti in poco tempo. Le referenze O.E.M. sono solamente indicative e non implicano che i pezzi di ricambio vengano da questo costruttore. Questa lista ricambi può essere aggiustata senza avvisi anticipati. Tutti i numeri, codici, nomi, foto, spaccati e disegni sono solo a titolo informativo.



Części z tego katalogu są zazwyczaj na stanie magazynowym. Również części które nie są wyszczególnione w katalogu mogą być dostarczone na zamówienie w najkrótszym możliwym terminie. Opis części O.E.M. jest używany informacyjnie i nie wskazuje na to, że dany produkt jest wyprodukowany przez podanego producenta. Zawartość katalogu może ulec zmianie bez wcześniejszego informowania o tym. Wszystkie użyte zdjęcia, rysunki, nazwy marek, opis i numery służą tylko do identyfikacji.



Запчасти из настоящего списка, как правило, имеются в запасе, если только он не распродан. Прочие, не фигурирующие в списке артикулы, могут быть поставлены в самые кратчайшие сроки. Указание оригинальных номеров производителя не предполагает обязательного оригинального происхождения самих деталей. Данный список может изменяться без предварительного уведомления. Все использованные фото, рисунки, иллюстрации, названия брендов, наименования и номера служат исключительно для цели идентификации.

Visita nuestro sitio Web :
www.bepcoparts.com

© **bepco** 2015

Todos los derechos reservados. Ninguna parte de este catálogo puede ser reproducida o comunicada en cualquier forma o por cualquier medio, electrónico o mecánico, incluyendo la copia, la grabación o el uso en un sistema de almacenamiento o recuperación de información, sin el permiso previo y explícito de BEPCO.

- BEPCO es un proveedor de piezas de recambio y accesorios adecuados para el mantenimiento y reparación de equipos originales.
Las referencias y marcas originales son puramente indicativas y no implican que los accesorios y / o piezas de recambio sean las del fabricante original.
- Los productos que no cumplan con los requisitos reglamentarios de la marca CE no se comercializan en el Espacio Económico Europeo.
- BEPCO® es una marca registrada.
- Todas las ventas están sujetas a los términos y condiciones generales de venta en www.bepcoparts.com
- Se incluyen fotografías e ilustraciones sólo a título indicativo. Sin responsabilidad por errores de impresión.

Recambios
para todas
las marcas
de la A a la Z

Case IH
David Brown
Fendt
Fiat
Ford
Hürlimann
JCB
John Deere
K.H.D. (Deutz)
Kubota
Landini
Lamborghini
Manitou
Massey Ferguson
Mc Cormick
Merlo
New Holland
Renault
Same
Steyr
Valmet
Zetor

moving forward in every field

REF. 90/999-107



HEAD OFFICE

Rue Chaumont 4D • 4480 Hermalle-sous-Huy • Belgium
T +32 (0)85 24 54 00 • F +32 (0)800 23 132 • info.be@bepcoparts.com • www.bepcoparts.com

Member of **TVH** 